

Advantage III

Gold Series by Ebtron

Installation, Operation and Maintenance Technical Manual

GTx116

“Plug & Play” Transmitters

Combination RS-485 and Dual Analog output model: GTC116
Combination Ethernet and Dual Analog output model: GTM116
LonWorks[®] output model: GTL116
Data Logger output model: GTD116

Document Name: *TM_GTx116_R9A1*



TM_GTx116_R9A1



European Union
Shipments

Models GTC116 and GTE116



BACnet is a registered trademark of ASHRAE. ASHRAE does not endorse, approve or test products for compliance with ASHRAE standards. Compliance of listed products to the requirements of ASHRAE Standard 135 is the responsibility of BACnet International (BI). BTL is a registered trademark of BI.

Models GTC116 and GTM116

Part Number: 930-0000

LIST OF EFFECTIVE AND CHANGED PAGES

Insert latest changed pages (in bold text); remove and dispose of superseded pages.
Total number of pages in this manual is **44**.

Page No	Revision *	Description of Change	Date
1, 2	.R9A	Updated revision to R9A	05/13/2016
3-44	.R9A	Minor corrections to reflect Advantage 3 Setup Menus changes for consistency among products	05/13/2016
1-44	.R8A	All pages revised/updated to reflect Advantage 3 updates	01/21/2015

TM_GTx116_R9A

Copyright © 2015, EBTRON[®], Inc.
All brand names, trademarks and registered trademarks are the property of their respective owners. Information contained within this document is subject to change without notice. Visit EBTRON.com to view and/or download the most recent versions of this and other documents.
All rights reserved.

Table of Contents

OVERVIEW	5	GTM116 - TRANSMITTER SETUP FOR ETHERNET	
SPECIFICATIONS	5	NETWORK OPERATION	19
ADVANCED TECHNOLOGY	5	GTM116 - Selecting Static or Dynamic IP Settings . . .	19
GTx116 TRANSMITTER FEATURES	6	GTM116 - Setting Ethernet Transmitter IP Address . . .	19
ORDERING GUIDE - GTx116 TRANSMITTER	6	GTM116 - Setting Subnet Mask	19
GTx116 TRANSMITTER INSTALLATION	7	GTM116 - Setting Gateway IP	19
GTx116 Mechanical Dimensions	7	GTM116 - Setting BACnet Protocol Mode	20
Power Transformer Selection	8	GTM116 - Setting Device Instance Number	20
Connecting Power to the Transmitter	8	GTM116 - Resetting Communications Options to Factory	
Connecting Sensor Probes to the Transmitter	9	Default Values	20
GTC116, GTM116 - COMBINATION ANALOG + NETWORK		GTM116 - ETHERNET WIRING CONNECTIONS	20
TRANSMITTER SETUP	10	GTL116 - LONWORKS TRANSMITTER SETUP	22
GTC/GTM116 - ANALOG OUTPUT		GTL116 - LONWORKS NETWORK CONNECTIONS	22
OUTPUT WIRING AND SETUP	10	GTL116 - LONWORKS INTERFACE	23
GTC116 - RS-485 NETWORK WIRING CONNECTIONS . . .	10	Introduction	23
RS-485 Network Cable Specifications	10	Basic Description	23
Connecting to an RS-485 Network:	10	GTL116 - VELOCITY AND FLOW VARIABLES	
GTx116 TRANSMITTER START-UP, INITIALIZATION AND SETUP		CONFIGURATION	24
MENUS	12	Velocity and Flow Variables	24
Changing the System of Units - IP units or SI Units . . .	12	Velocity and Flow Configuration Properties	24
GTx116 TRANSMITTER CALIBRATION	12	GTL116 - AREA INPUT VARIABLE	25
GTx116 LCD DISPLAY NOTIFICATIONS	12	Area Input Variable	25
Factory Default Menu Settings for GP1 Sensor Probes . . .	13	Pressure Variables	25
GTx116 CHANGING FACTORY DEFAULT SETUP		Pressure Configuration Properties	25
MENU SETTINGS	14	Temperature Variables and Configuration Properties . . .	26
Setup Menu Options	14	Temperature Configuration Properties	26
Selecting Actual and Standard Output Measurement Type .	14	GTL116 - DEFAULT DELTA VALUES	26
Output Scaling	14	EB-Link WIRELESS INFRARED COMMUNICATIONS OPTION . . .	27
Changing the LCD Display from Volumetric Flow		EB-Link Card Installation	27
CFM to Velocity FPM	14	Obtaining and Installing EB-Link Software	28
Converting the Analog Output Signal from FPM to CFM . . .	14	EB-Link Reader Software	28
Locking the Configuration Settings	14	EB-Link Software for PDA Devices	28
VIEWING SENSOR DATA	15	Real Time Duct Traverses Using EB-Link	28
Viewing Sensor Data on the Local LCD Display	15	FIELD ADJUSTMENTS	29
Viewing Sensor Data over BACnet or Modbus Networks or		ALTITUDE CORRECTION ADJUSTMENT	29
through the EB-Link Reader	15	ADJUSTING THE LOW LIMIT CUTOFF	29
Sensor Addressing and Probe Positioning	15	FACTORY CALIBRATION ADJUSTMENTS	29
GTC/GTM116 - ALARM FEATURES	16	Field Adjustment Wizard - AUTOMATED FIELD ADJUSTMENT	29
Average Alarm (AO2 ASGN=ALRM)	16	Overview of the Field Adjustment Wizard	29
Trouble Alarm (AO2 ASGN=TRBL)	16	Engaging and Using the Field Adjustment Wizard . . .	29
No Fault (NO FAULT=HI)	16	MANUAL ADJUSTMENT OF FACTORY OFFSET/GAIN	
Alarm Indications	16	CALIBRATION	29
Low Alarm - "LO ALRM= ON"	16	Procedure for 1 Point Field Adjustment	30
High Alarm - "HI ALRM= ON"	16	Procedure for 2 Point Field Adjustment	30
Trouble Alarm - "AO2 ASGN=TRBL"	16	MAINTENANCE	31
GTC/GTM116 - ANALOG OUTPUT TYPE SELECTION AND		GENERAL TROUBLESHOOTING (All GTx116 Systems) . . .	32
SETUP	17	GTC116 (ANALOG OPERATION) TRANSMITTER	
GTC/GTM116 - Converting Analog Output Signal		TROUBLESHOOTING	33
Values to Airflow and Temperature	17	GTM116 ETHERNET TRANSMITTER TROUBLESHOOTING . . .	34
GTC/GTM116 - OUTPUT TEST - Sending a Test Output		GTL116 LonWorks TRANSMITTER TROUBLESHOOTING . . .	34
Signal to the Host Control System	17	APPENDIX A - WIRING DIAGRAMS	35
GTC116 - TRANSMITTER SETUP FOR RS-485 NETWORK		GTC116 Combination Analog/RS-485 Output Transmitter	
OPERATION	18	Wiring Diagram	35
GTC116 - RS-485 Network Options and		GTM116 Combination Analog/Ethernet Output Transmitter	
Communications Menu Settings	18	Wiring Diagram	36
GTC116 - Setting Transmitter Termination for		GTL116 LonWorks Output Transmitter Wiring Diagram . . .	36
RS-485 Network	18	APPENDIX B - GTx116 SETUP MENUS	37
GTC116 - Setting RS-485 Network Protocol	18		
GTC116 - Setting Transmitter Address	18		
GTC116 - Setting Baud Rate	18		
GTC116 - Setting Modbus Parity	18		
GTC116 - Setting BACnet Device Instance Number . . .	18		
GTC116 - Resetting Communications Options to			
Factory Default Values	18		

List of Figures

Figure 1. GTx116 Transmitter5
 Figure 2. GTx116 Transmitter Features6
 Figure 3. GTx116 Transmitter Ordering Guide6
 Figure 4. GTx116 Transmitter Mechanical Detail Drawing7
 Figure 5. GTx116 Power Connections8
 Figure 6. Type A and Type B Transmitter Detail9
 Figure 7. Connector Detail9
 Figure 8. GTC116 Combination Analog/RS-485 Transmitter Interior Detail11
 Figure 9. GTM116 Combination Analog/Ethernet Transmitter Interior Detail11
 Figure 10. Example of Probe Mounting and Connector Locations for Proper Decoding of Traverse and EB-Link Data15
 Figure 11. GTL116 LonWorks Transmitter Interior Detail22
 Figure 12. EB-Link Installation Detail27
 Figure 13. EB-Link Reader and PDA Devices28
 Figure 14. Typical EB-Link Data Acquisition28
 Figure A-1. Model GTC116 Combination Analog/RS-485 Wiring Diagram35
 Figure A-2. Model GTM116 Combination Analog/Ethernet Wiring Diagram36
 Figure A-3. Model GTL116 LonWorks Wiring Diagram36
 Figure B-1. TM_GTx116 System of Units Menu38
 Figure B-2. TM_GTx116 Setup Menu38
 Figure B-2. GTx116 Setup Menu38

List of Tables

Table 1. GTx116 Connectivity Options6
 Table 2. GTx116 Power Transformer Selection Guide8
 Table 3. Standard “IP” and “SI” Menu Units Abbreviations12
 Table 4. Factory Default Menu Settings13
 Table 5. GTx116 Alarm Types and Notifications16
 Table 6. GTC/GTM116 Converting Analog Output Values to Airflow/Temperature17
 Table 7. GTM116 TCP/IP Example20
 Table 8. GTx116 BACnet Object List21
 Table 9. GTx116 Modbus Register Map21
 Table 10. GTL116 LonWorks Node Velocity and Flow Variables24
 Table 11. GTL116 LonWorks Node Velocity and Flow Configuration Properties24
 Table 12. GTL116 LonWorks Area Input Variable25
 Table 13. GTL116 LonWorks Node Pressure Variables25
 Table 14. GTL116 LonWorks Node Pressure Configuration25
 Table 15. GTL116 LonWorks Node Temperature Variable26
 Table 16. GTL116 LonWorks Node Temperature Variable26
 Table 17. General Troubleshooting (All GTx116 Systems)32
 Table 18. GTC116 and GTM116 - Analog Operation Transmitter Troubleshooting33
 Table 19. GTC116 RS-485 Transmitter Troubleshooting33
 Table 20. GTM116 Ethernet Transmitter Troubleshooting34
 Table 21. GTL116 LonWorks Transmitter Troubleshooting34

TM_GTx116_R9A

OVERVIEW

EBTRON's GTx116-P+ transmitter is designed for measurement of airflow and temperature in duct and plenum applications. The GTx116-P+ transmitter accepts from one to four model GP1 probes with a total of up to 16 sensors and provides individual flow and temperature readings as well as average readings. A programmable alarm feature can be set for average flow low limit, high limit and system/probe/sensor faults. Analog output 2 (OUT2) can be configured as active low (OVDC or 4mA) or active high (5/10VDC or 20mA) when assigned as an alarm output on GTC116 and GTM116 models. The transmitter is fully independent of the sensors and does not require field matching to them. It includes a 16 character LCD display for airflow, temperature and system configuration and diagnostics. Field configuration is accomplished through a simple four-button interface on the main circuit board. Individual sensor airflow and temperature measurements can be displayed from the diagnostic mode and are beneficial as an HVAC system diagnostic tool. The airflow output signal can be filtered, and a process low limit can be set to force the output to zero when airflow falls below a user defined value. A Field Adjustment Wizard feature can be engaged for one or two point field adjustment in applications where field adjustment is required. The GTx116-P+ transmitter is available in analog output and network output versions.

SPECIFICATIONS

Maximum Sensing Points

- 16 (16 airflow + temperature, independently processed)

Sensor System Configuration (max.)

- Type A (probes x sensors): 2x8
- Type B (probes x sensors): 4x4

Digital Signal Processing

- Microprocessor: Yes
- Multiplexing: 32 channels
- A/D Converter: 12-Bit

"Plug and Play" Sensor Systems

- Probes do not require matching to transmitter

Power Requirements

- 24 VAC (22.8 to 26.4 VAC), at 12 to 20 VA (dependent on number of sensors); isolation not required
- "Brownout" protection: "Watchdog" reset circuit
- Protection: Over voltage, over current and surge protection

Enclosure

- Aluminum

User Interface

- Pushbutton and LCD display

Display

- 16 character alpha-numeric display (auto-ranging)

Output to Host Controls

GTC116, GTM116: (Combination Dual Analog Output + Network models):

Analog Output: Isolated dual 0-10VDC / 0-5VDC (resolution 0.010 / 0.020% FS) or 4-20mA **and:**

for **GTC116:** Dual analog plus RS-485 Output at 76.8 kbps max BACnet[®], Modbus **or**

for **GTM116:** Dual Analog plus 10-BaseT Ethernet, BACnet, Modbus, and TCP/IP

GTL116: LonWorks[®] Free Topology Transceiver (no analog output)

Airflow Output Adjustments:

- Field Adjustment Wizard
- Offset/gain
- Airflow Output adjustable integration 1 to 1000
- Airflow Low Limit Cutoff: Forces output to zero below defined value
- Alarm Output programmable for low and high limits

System Diagnostics

- Sensor/transmitter diagnostics mode and alarm output option

Environmental Limits

- Operating Temperature: -20° F to 120° F (-28.8° C to 48.8° C)
- Moisture: 0 to 99% rh, non condensing (protect from water)

Compatible Sensor Systems

- GP1 probes
- GB1 differential airflow sensors

Listings

- UL[®] 873 Airflow & Temperature Indicating Devices
- CE (EU shipments only)
- BACnet BTL Listing

Warranty

- 36 months from shipment



Figure 1. GTx116 Transmitter

ADVANCED TECHNOLOGY

- Microprocessor-based electronics with industrial grade integrated circuits.
- "Plug and Play" design.
- Accepts from 1 to 4 probes with maximum of 16 airflow and temperature sensors.
- LCD display and Push-button user interface for simple field configuration and diagnostics.
- Programmable Alarm Output (models GTC116 and GTM116) for average flow low/high limits or system/sensor faults.
- Independent airflow and temperature output.
- Analog output signals and network protocols available for interface with virtually all modern building automation systems.

Network Connectivity Solutions



Modbus

Ethernet

GTx116 TRANSMITTER FEATURES

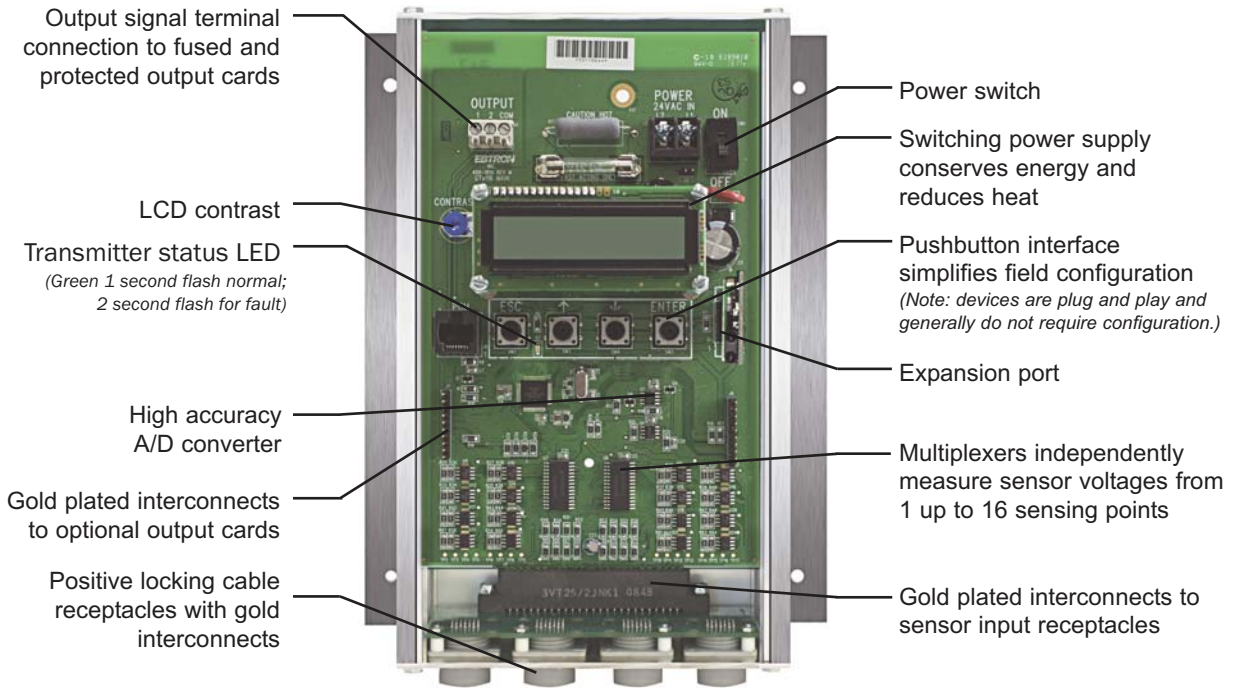

Figure 2. GTx116 Transmitter Features

ORDERING GUIDE - GTx116 TRANSMITTER

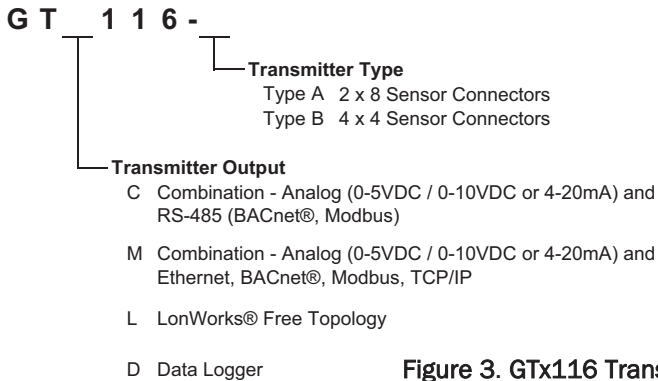

Figure 3. GTx116 Transmitter Ordering Guide

Table 1. GTx116 Connectivity Options

Output to Host Controls	Output/Protocols Supported	Airflow	Temperature	Status
Combination Analog / RS-485 Model GTC116	Analog: Linear 0-5VDC / 0-10VDC or 4-20mA	Yes	Yes	Yes
	RS-485: BACnet®-MS/TP, Modbus-RTU	Yes	Yes	Yes
Combination Analog / Ethernet Model GTM116	Analog: Linear 0-5VDC / 0-10VDC or 4-20mA	Yes	Yes	Yes
	BACnet® Ethernet			
	BACnet®-IP			
	Modbus-TCP			
	TCP/IP			
LonWorks® - Model GTL116	Free Topology Transceiver	Yes	Yes	Yes
Data Logger - Model GTD116	Connectivity is not available while the Data Logger is connected. Airflow, temperature and timestamp are recorded on the attached USB thumb-drive.			

TM_GTx116_R9A

GTx116 TRANSMITTER INSTALLATION

The GTx116 transmitter is designed for use in an environment between -20° F to 120° F (-28.8° C to 48.8° C) where it will not be exposed to rain or snow.

The transmitter should be mounted upright in a field accessible location. The enclosure (Figure 4) is designed to accept 1/2 in. (12.7 mm) electrical fittings for signal and power wiring at the top left and right sides of the circuit board. The transmitter should be located such that the connecting cables from all of the sensor probes reach the receptacles on the bottom of the transmitter enclosure.



In locations exposed to direct rain and/or snow, the transmitter must be enclosed in a NEMA4 enclosure.



Leave unobstructed space of at least 9 in. (228.6 mm) above, 2 in. (50.8 mm) to each side and 3.5 in. (88.9 mm) below the transmitter to allow for cover removal, sensor connections and heat dissipation.



Locate the transmitter in a location that can be reached by all connecting cables from the sensor probes.



Do not drill into the transmitter enclosure since metal shavings could damage the electronics.

GTx116 Mechanical Dimensions

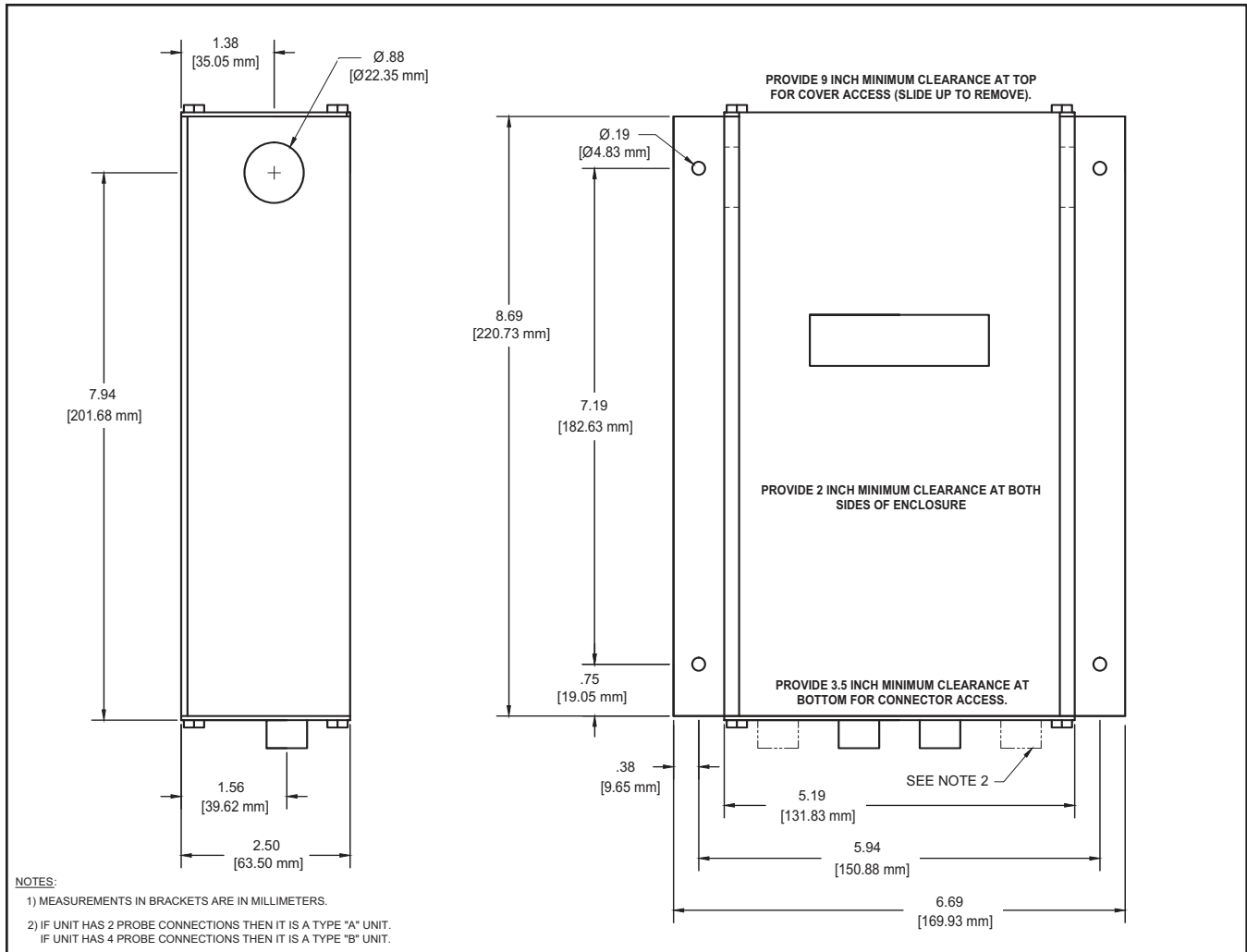

Figure 4. GTx116 Transmitter Mechanical Detail Drawing

Power Transformer Selection

Select a 24 VAC transformer based on the maximum power requirements indicated on the transmitter label (20 VA) or from the table below. The operating supply voltage (transmitter power “ON” with all sensor probes connected) should not be less than 22.8 VAC or greater than 26.4 VAC.

Table 2. GTx116 Power Transformer Selection Guide

Total Sensors	Minimum VA Req.	Total Sensors	Minimum VA Req.	Total Sensors	Minimum VA Req.	Total Sensors	Minimum VA Req.
1	12	5	14	9	17	13	19
2	13	6	15	10	17	14	19
3	13	7	15	11	18	15	20
4	14	8	16	12	18	16	20

Connecting Power to the Transmitter

Slide the cover plate up and off of the transmitter enclosure, and ensure that the power switch is in the “OFF” position before connecting the 24 VAC power source.

Connect 24 VAC power to the large, two position power input terminal labeled “POWER” on the upper right hand side of the main circuit board (Figure 5). Since the output signals are isolated from the power supply, it is not necessary to provide an isolated (secondary not grounded) power source.

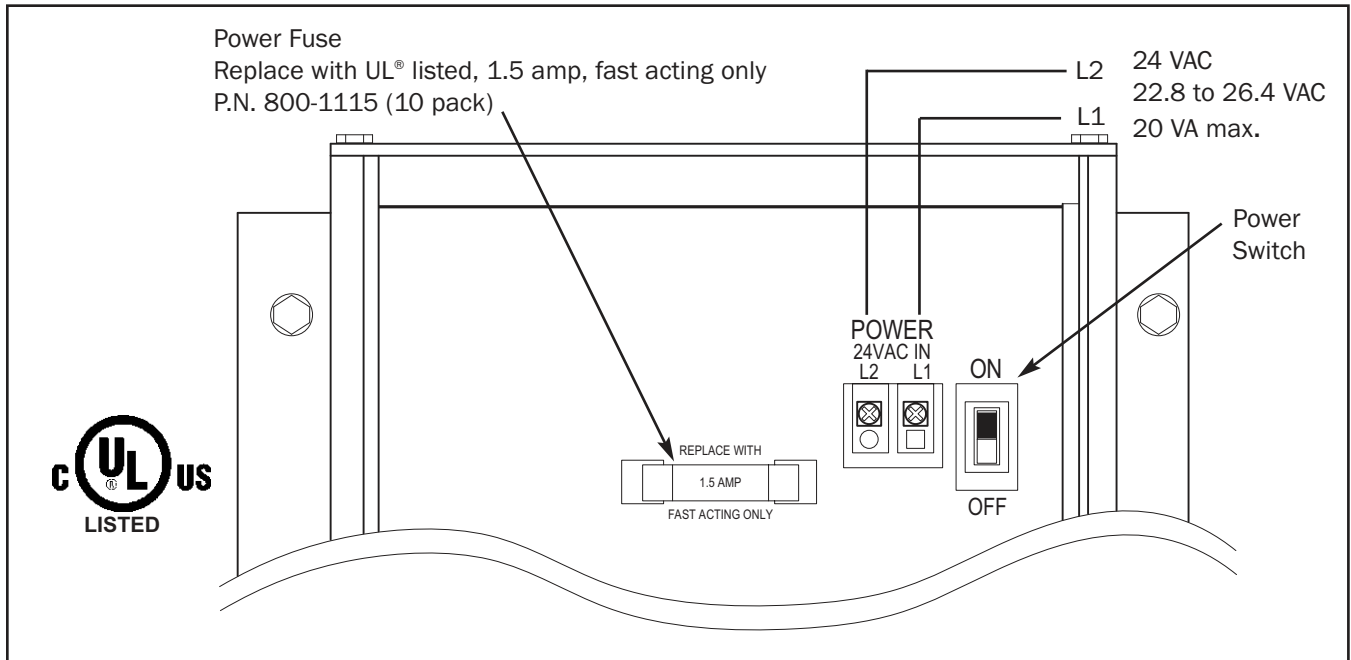

Figure 5. GTx116 Power Connections



TM_GTx116_R9A



Multiple GTx116 transmitters wired to a single transformer must be wired “in-phase” (L1 to L1, L2 to L2).

Connecting Sensor Probes to the Transmitter

After mounting the sensor probes and transmitter, connect one or more sensor probe cable plugs to the circular receptacles located at the bottom of the GTx116 transmitter enclosure. Probes are “Plug and Play” and do not have to be connected to a specific receptacle on the transmitter (unless traverse data is desired - see note below).

-  Provide a “drip loop” at the transmitter if there will be the potential for water runoff or condensation along the sensor probe cable(s).
-  Sensor probe cable plugs are “keyed” as shown in Figure 7. Line up plug with receptacle and push straight on to receptacle. **DO NOT TWIST.** Squeeze cable plug “ribs” towards receptacle when removing. Forcing the cable plug in or out of the receptacle will damage the connectors and void warranty.
-  If traverse data is desired, probes should be installed and connected to the transmitter using the mounting convention specified in the separate GP1 sensor probe manual. Proper installation simplifies sensor location decoding during data analysis.

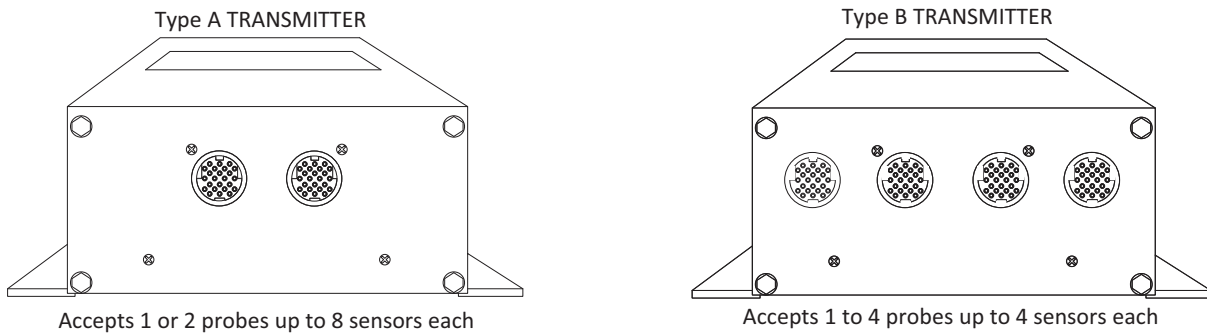

Figure 6. Type A and Type B Transmitter Detail

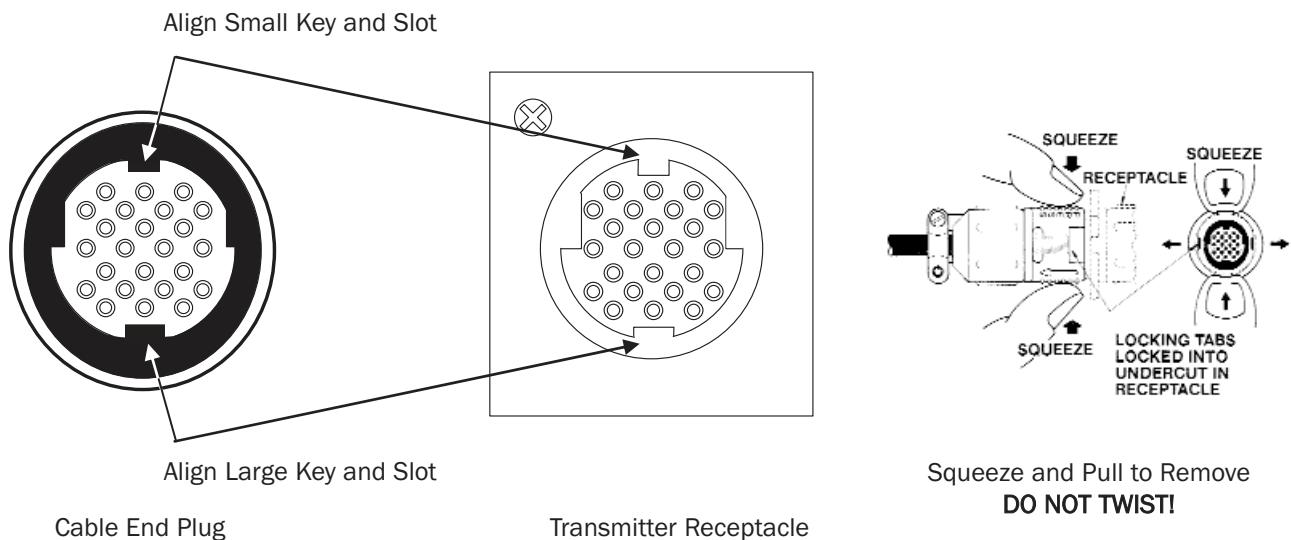

Figure 7. Connector Detail

TM_GTX116_P9A

GTC116, GTM116 - COMBINATION ANALOG + NETWORK TRANSMITTER SETUP

The GTC116 Combination card option allows simultaneous analog outputs and RS-485 differential bus/line transceiver outputs designed to integrate with various network protocols.

The GTM116 Combination Analog/Ethernet card option allows simultaneous analog outputs and full duplex IEEE 802.3 ethernet interface with automatic re-transmission on collision and cyclic redundancy checking on network data. An on-board microcontroller performs over 7 million instructions per second to insure minimal network latency. Link status as well as network activity are available via on-board LED indicators.

The GTC116 and GTM116 combination cards plug directly onto the main circuit board as shown in Figures 8 and 9.

GTC/GTM116 - ANALOG OUTPUT OUTPUT WIRING AND SETUP

Analog output connections are made at the top left of the transmitter main circuit board OUTPUT connector as shown in Figures 8 and 9. Independent 12-bit (4096 discrete states) linear analog outputs are provided for airflow at OUTPUT terminal 1, and for temperature (or alarm) at OUTPUT terminal 2, each with over voltage and over current protection. **Airflow and temperature outputs are field selectable for either 0-5/0-10VDC or 4-20 mA.** The OUTPUT terminal 2 can be assigned as an Alarm output to provide an active high, active low or trouble alarm output. Outputs are galvanically isolated from the main power supply to permit simple integration with virtually all building automation systems.



When configured for a 4-20mA output, the GTC116 is a "4-wire" device. The host controls shall not provide any excitation voltage to the output of the GTC116.

To wire the analog output signals, slide the cover plate up and off of the enclosure. Ensure that the power switch is in the "OFF" position. Connect signal wires for airflow rate and temperature (or alarm) to the small, three position output terminal labeled "OUTPUT" on the upper left hand side of the main circuit board as indicated in Figure 8. Airflow output is at terminal 1, and temperature, airflow alarm or trouble alarm output is at terminal 2.

GTC116 - RS-485 NETWORK WIRING CONNECTIONS

Refer to Figure 8, and the following paragraph for network wiring considerations.

RS-485 Network Cable Specifications

The RS-485 network cable shall be shielded twisted pair with a characteristic impedance of 100 to 130 ohms. Distributed capacitance between conductors shall be less than 100 pF per meter. Distributed capacitance between conductors and shield shall be less than 200 pF per meter. The maximum recommended length of a network segment is 1200 meters with AWG 18 cable.

Connecting to an RS-485 Network:

Connect the NET+, NET- and COM terminals with shielded twisted pair cable meeting the specifications defined in the previous paragraph (typically using two pairs, with one wire not used; one pair for +/- and [at least one of] the wires in other pair for COM when using 2-pair cable). The connection to the network must be made in a "daisy chain" configuration. "T" connections and stubs are NOT permitted. The shield should be terminated at one end on the network only.

***CAUTION**



For ISOLATED output, the **COM** connection MUST BE CONNECTED to the network common for proper operation. In addition, when the Analog Output is concurrently used with the RS-485 Output, the Common connection for both Analog and RS-485 Outputs must be at the same potential.



For NON-ISOLATED output, the **COM** connection MUST BE CONNECTED to the common ground that is used by the other network devices (typically the ground side of the 24VAC supply; the L2 terminal at the POWER connector block as shown in Figure 8). In addition, when the Analog Output is concurrently used with the RS-485 Output, the Common connection for both Analog and RS-485 Outputs must be at the same potential.

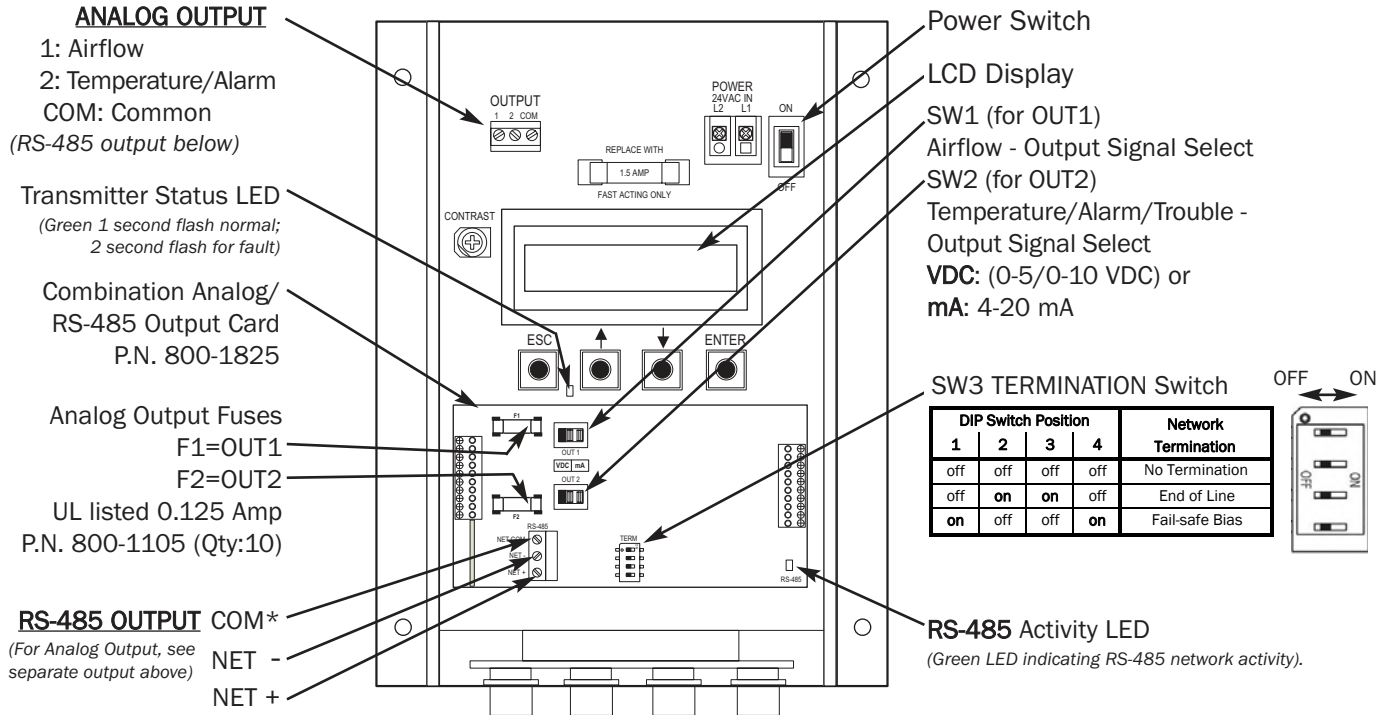

***CAUTION**

⚠ The common for the ANALOG and the RS-485 outputs must be at the same potential.
For **ISOLATED** RS-485 output, **COM** connection **MUST BE CONNECTED** to network common.
For **NON-ISOLATED** output, **COM** connection **MUST BE CONNECTED** to the common ground that other network devices are using (typically the ground side of the 24VAC supply - L2 of the POWER terminals). Refer to **RS-485 Network Wiring Connections** paragraph for additional detail.

Figure 8. GTC116 Combination Analog/RS-485 Transmitter Interior Detail

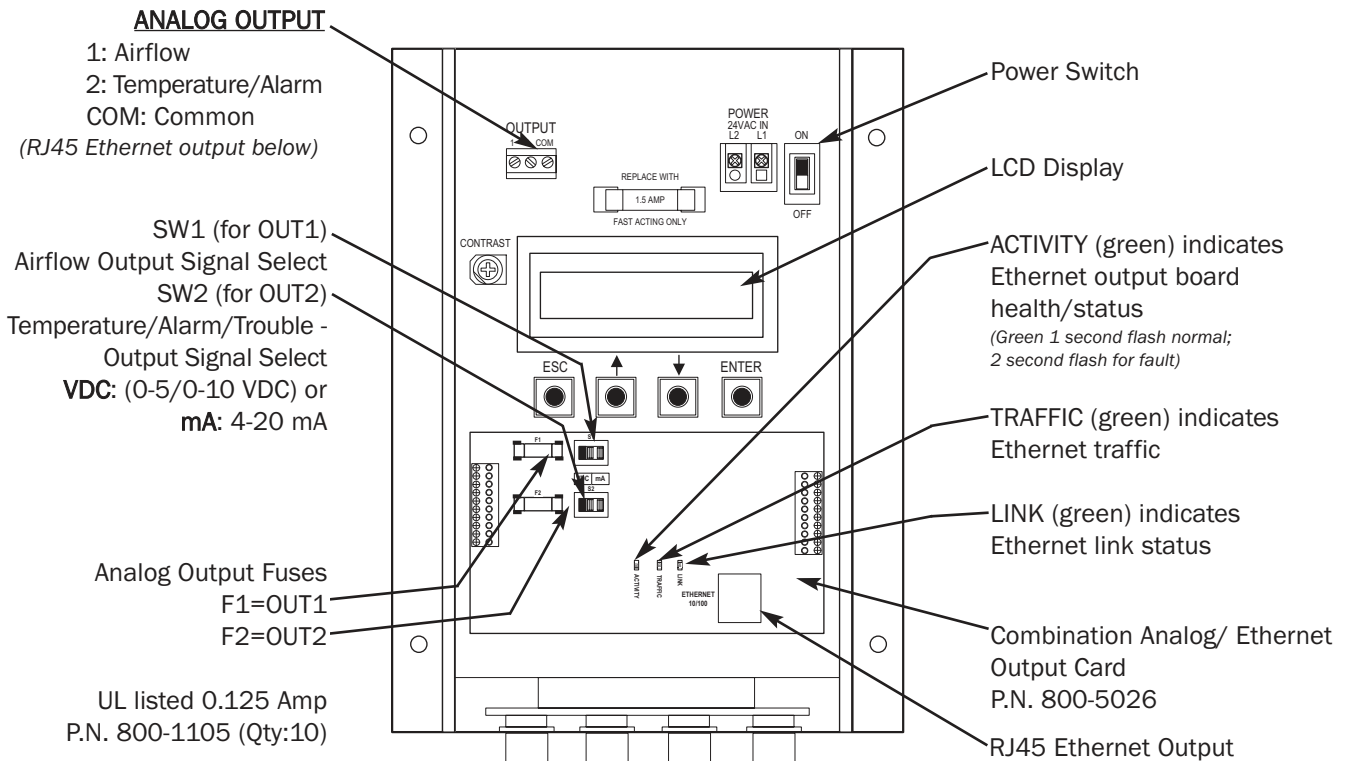

Figure 9. GTM116 Combination Analog/Ethernet Transmitter Interior Detail

GTx116 TRANSMITTER START-UP, INITIALIZATION AND SETUP MENUS

To ensure a successful start-up, verify that the airflow measuring station and transmitter are installed in accordance with **EBTRON** guidelines.



Check the physical installation, power connections and model specific signal wiring prior to turning the power switch to the “on” position.

Move the power switch to the “ON” position. The transmitter executes a complete self-check each time the power is turned on that takes 10 seconds to complete.

The GTC116 and GTM116 default analog output signals are set to 4-20mA. The output signal can be changed to 0-5VDC/0-10VDC using board by setting switches SW1, SW2 and then entering the desired setting in the Setup menu. The GTC116, GTM116 and GTL116 must be properly configured based on the system network protocol. Review the section for the corresponding transmitter output card or contact **EBTRON** Customer Service, toll free, at 800-232-8766.

Changing the System of Units - IP units or SI Units

The GTx116 transmitter is provided with the system of units set to I-P. To change to S.I., simultaneously press and release the “ENT” and “ESC” buttons during normal operation. “IP/SI UNITS” will be indicated on the LCD display. Refer to Appendix B SYSTEM OF UNITS MENU for details on the System of Units menu. Note that Setup Menu items are shown in IP System Of Units. When SI System of Units is selected, the units of measure abbreviations used in the menus is shown in Table 3.

Table 3. Standard “IP” and “SI” Menu Units Abbreviations

“IP” System of Units	Description	“SI” System of Units	Description
FPM	Feet per minute	MPS	Meters per second
CFM	Cubic feet per minute	LPS	Liters per second
SQF	Square feet	SQM	Square meters
F	Fahrenheit	C	Celsius

GTx116 TRANSMITTER CALIBRATION

The GTx116 uses high quality industrial grade components and is designed for years of trouble-free operation. Periodic recalibration of the transmitter is neither required or recommended. Transmitter field calibration verifiers are available for purchase from **EBTRON** for installations requiring periodic validation of instrumentation. Contact **EBTRON** for more information.

GTx116 LCD DISPLAY NOTIFICATIONS

Following a brief initialization at power up, the LCD display automatically displays airflow and temperature with units of measurement in all upper case (caps) characters. The display provides additional information on system status and alarm conditions. Refer to the **ALARM FEATURES** section of this manual for additional detail on Alarm and Trouble Error code indications.

Factory Default Menu Settings for GP1 Sensor Probes

The GTx116 transmitter is “plug and play” and does not require setup unless a network option is selected that requires configuration. Table 4 shows the factory default settings for all compatible sensor probes.

To change the Factory Default Settings, see: CHANGING FACTORY DEFAULT SETUP MENU SETTINGS.

Table 4. Factory Default Menu Settings

Display	Description	I-P	S.I.
AIRFLOW=	Airflow measurement method, Actual or Standard.	ACT	ACT
*LCDU/M=	Airflow units of measure	ACFM	LPS
*AREA=	Free area where station is located (required for volumetric measurement)	0.00 sq.ft. (see note)	0.000 sq.meters (see note)
*AO1 SGNL=	GTC/GTM116 output 1 signal type voltage or mA (airflow)	mA	mA
*AO1 UM=	Output 1 units of measure	AFPM	MPS
*AO1 FS=	GTC/GTM116 output 1 signal full scale	5,000 FPM	25 MPS
*LLIMIT=	GTC/GTM116 low limit cutoff	0 AFPM	0 AMPS
*FLOW ADJ=	Output 1 Offset-Gain On/Off	Off	Off
*GAIN=	Output 1 Gain factor	1.000	1.000
*OFF=	Output 1 Offset factor	0.000	0.000
*TEMP METH=	Temperature Averaging	Weighted Avg.	Weighted Avg.
*AO2 SGNL=	GTC/GTM116 output 2 signal voltage or mA (temperature or alarm)	mA (see alarms)	mA (see alarms)
*AO2 MS=	GTC/GTM116 output 2 signal minimum scale	-20° F	-30° C
*AO2 FS=	GTC/GTM116 output 2 signal full scale	160° F	70° C
*LCD INTG=	Number of flow calculations to be averaged for LCD display.	100	100
*AO1 INTG=	Number of flow calculations to be averaged for AO1 output.	30	30
*EB-LK INT=	Number of flow calculations to be averaged for EB-Link readings.	300	300
*ALT=	Altitude for flow correction relative to mean sea level (0 ft).	0 ft	0 m
*AO2 ASGN =	Output 2 Assigned Type: Temperature/Alarm	TEMP	TEMP
*SETPNT=	Alarm setpoint value. When AO2 ASGN=ALARM , operates in conjunction with TOL= value.	0	0
*TOL=	Alarm range tolerance value. When AO2 ASGN=ALARM , this setting establishes the alarm range relative to the SETPNT= value.	10%	10%
*NO FAULT=	Sets the AO2 normal (not alarm) output state relative to the full scale analog output selected. HI provides maximum full scale under normal conditions and minimum scale during alarm. LO provides minimum full scale under normal conditions and maximum scale during alarm.	HI	HI
*DELAY=	Time that the alarm condition must exist before alarm output is activated.	2 minutes	2 minutes
*ZERO OFF =	Set to YES to inhibit LO alarm condition when flow reading is zero (dependent on LLIMIT= setting). Set to NO to disable this feature.	NO	NO
*RESET =	Set to AUTO to have alarm self-clear when alarm condition no longer exists. Set to MANUAL to require manual reset of alarm.	AUTO	AUTO

Note: For GP1 probes, area is stored in one-wire, but can be changed.

GTx116 CHANGING FACTORY DEFAULT SETUP MENU SETTINGS

Setup Menu Options

The GTx116 Transmitter is setup and tested at the factory to be fully operational when sensor probes are connected and power is applied (set the power switch to the “ON” position). Factory settings can easily be changed using the SETUP MENU by simultaneously pressing and releasing the “UP” and “DOWN” buttons while the transmitter is in its normal operating mode. Navigate through the menu using Appendix B to make changes to the transmitter configuration. The settings take effect immediately. The following are common field modifications to the factory default settings.

Selecting Actual and Standard Output Measurement Type

The transmitter is set from the factory to provide actual airflow measurement units (displayed as “ACFM” and “AFPM”). In this mode, airflow measurements are calculated for actual airflow conditions. If using Actual airflow, corrections for altitude are entered through the **ALT=** setting in the Setup menu. If desired, the output can be set to provide standard airflow measurement units (displayed as “SCFM” and “SFPM”) which provides measurements that are corrected to standard conditions.

Output Scaling

EBTRON's Gold Series sensors are individually calibrated between 0 and the factory default full scale in wind tunnels to standards traceable to the National Institute of Standards and Technology (NIST). Sensors are independent and produce “percent of reading” accuracy. Changing the full scale does not change the accuracy of the device. Factory default output scaling for analog GTC116 and GTM116 transmitters can be changed using setup menus of Appendix B.

Changing the LCD Display from Volumetric Flow CFM to Velocity FPM

The GTx116 transmitter is shipped from the factory to indicate volumetric flow. To display velocity in FPM, enter the SETUP menu and in the DISPLAY submenu, change the “*LCD UM=ACFM” to “*LCD UM=AFPM”. Changing the LCD display units will not affect the analog output signal.

Converting the Analog Output Signal from FPM to CFM

The GTx116 transmitter is shipped from the factory with analog output “OUTPUT 1” set to indicate velocity in AFPM. To automatically convert this analog velocity output to volumetric flow (ACFM), simply set the *AO1 UM from AFPM (default) to ACFM in the SETUP menu. If you wish to manually convert the velocity output to volumetric flow (ACFM), simply multiply the indicated output velocity (in FPM) by the free area of the air flow probe installation location. Refer also to Table 6 for a complete listing of conversions for each of the analog outputs of the GTx116. The AO1 full scale analog output (OUTPUT1) value is determined by the AO1 FS setting within the SETUP menu.

Locking the Configuration Settings

The GTx116 transmitter configuration settings can be locked at one of three security levels within the SECURITY submenu using the LOCK SEC= item.

When LOW security level is selected (LOCK SEC=LOW) the last 4 digits of the board serial number are automatically assigned as the lock code. To see the board serial number, navigate to DIAGNOSTICS menu in SERIAL NUMBERS item.

When the MED security level is selected (LOCK SEC=MED) the user enters and confirms a security code. In the event that this code is lost/misplaced, EBTRON can provide a key that is unique to the transmitter to unlock it. Contact EBTRON customer service for this code.

When the HIGH security level is selected (LOCK SEC=HIGH) the user enters and confirms a security code. In the event that this code is lost/misplaced, the transmitter must be returned to the factory in order to unlock it.



When LOCK SEC=HIGH is selected, the user defined setting can only be changed after entering the user defined code. STORE THE LOCK CODE IN A SAFE LOCATION! For security reasons, the HIGH level lock code can only be reset by returning the transmitter to the factory.

VIEWING SENSOR DATA

Viewing Sensor Data on the Local LCD Display

Airflow and temperature of individual sensors can be displayed on the local LCD display by entering the Diagnostic Menu. Simultaneously depress the up ↑ and down ↓ arrows to enter the GTx116 SETUP menu, and then navigate to the Diagnostic submenu.

Viewing Sensor Data over BACnet or Modbus Networks or through the EB-Link Reader

Airflow and temperature of individual sensors can be read across BACnet or Modbus networks, or downloaded directly to an EB-Link Reader if the infra-red EB-Link option has been installed. Refer to the following Sensor Addressing and Probe Positioning paragraph for the suggested probe installation configuration. Tables 5 and 6 provide BACnet objects and register addressing information for individual sensor data.

Sensor Addressing and Probe Positioning

Sensors are automatically addressed after power is applied to the transmitter as follows:

The probe connected to the left most connector, C1, is defined as probe 1. The sensor opposite the cable end of the probe is defined as sensor 1 when viewing individual sensor data. Refer to Figure 10 below for additional detail.

Note that if only average data is desired, the mounting position of the probes is not critical. When a probe is disconnected and then plugged in to a different port, the transmitter will re-discover it within 15 seconds and make any necessary addressing adjustments.

To standardize installation and decoding of data, particularly when using the EB-Link Reader product, EBTRON recommends a left to right (or top to bottom in vertical applications) sensor probe mounting convention as detailed in the separate sensor probe installation instructions.

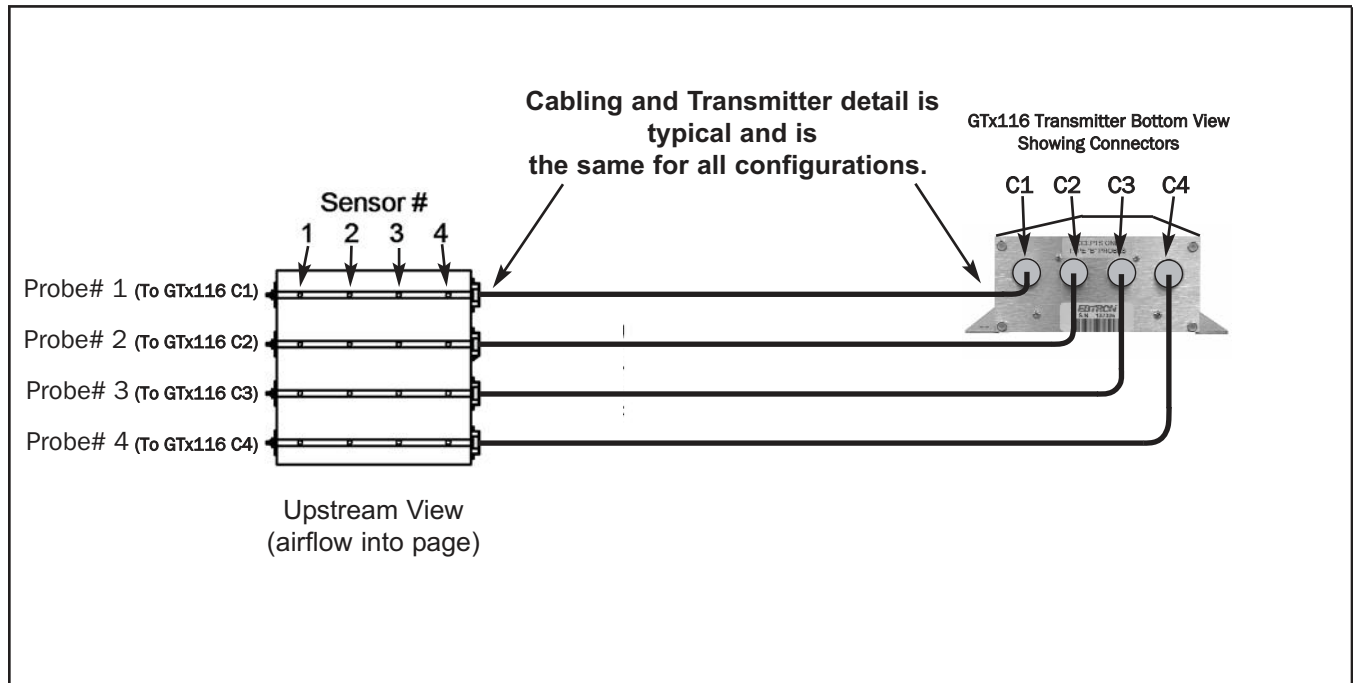

Figure 10. Example of Probe Mounting and Connector Locations for Proper Decoding of Traverse and EB-Link Data

GTC/GTM116 - ALARM FEATURES

Analog output AO2 (OUT2) can be assigned to function as an alarm output. The AO2 alarm output can be assigned in the SETUP menu to operate as an average alarm (AO2 ASGN=ALRM) or as a trouble alarm (AO2 ASGN=TRBL) for monitoring the status of the transmitter and sensors. The AO2 ASGN= setting is located in the ANALOG OUT submenu of the SETUP menu. The transmitter LCD display will indicate the Alarm status for 2 seconds, and will cycle through any other alarms if multiple alarm events are active for 2 seconds each, and then display the current actual flow for 2 seconds. Detailed set up of the Alarm features is shown in the Setup menu.

Average Alarm (AO2 ASGN=ALRM)

AO2 output is assigned as an average airflow alarm output. Useful for applications where a low flow alarm, a high flow alarm for operation outside of a defined range (setpoint and tolerance) is required.

Trouble Alarm (AO2 ASGN=TRBL)

AO2 output is assigned as a transmitter trouble alarm indicating a fault within the transmitter or a sensor of the airflow measurement system. The transmitter LCD will indicate a trouble code and a brief description of the trouble. Contact EBTRON customer service for additional information or assistance with trouble codes.

No Fault (NO FAULT=HI)

When AO2 output is assigned as an alarm, this setting configures the normal output condition to be HI or LO relative to the full scale analog output level selected when no fault condition exists.

Alarm Indications

Table 6 details the alarm types, LCD indications and AO2 alarm output indication. User can select either or both of the two Average Alarms or the Trouble Alarm.

Low Alarm - “LO ALRM= ON”

The Low Alarm is activated when the average airflow falls to a defined level below the SETPNT= value. The defined level is equal to the SETPNT= value minus the calculated value of (TOL= value * SETPNT= value). Once active, the alarm can be cleared when the average airflow rises above the set point minus calculated tolerance value.

High Alarm - “HI ALRM= ON”

The High Alarm is activated when the average airflow rises above a selected set point (SETPNT=) + tolerance (TOL=) value. Once active, the alarm can be cleared when the average airflow falls below the set point + tolerance value.

Trouble Alarm - “AO2 ASGN=TRBL”

The Trouble alarm provides trouble codes useful for isolating setup issues or problems within the transmitter or sensors. The transmitter LCD will indicate TROUBLE! regardless of whether AO2 is assigned to TRBLE. The Diagnostic submenu can be engaged for the error code and a brief description of the trouble. Contact EBTRON customer service for information on troubleshooting using the Trouble error codes.

Table 5. GTx116 Alarm Types and Notifications

ALARM OUTPUT ASSIGNMENT TYPE	LOCAL LCD DISPLAY OF ALARM TYPE AND NOTIFICATION	ANALOG OUTPUT 2 ALARM INDICATION	NETWORK ALARM INDICATION
LOW ALARM (Average Alarm)	Display alternates between **LOW ALARM** (then any other alarms) and actual reading for 2 seconds each.	On alarm or trouble, OUT2 is active high (or active low) relative to the full scale maximum (or minimum) analog value as determined by the SETUP Menu “NO FAULT=” selection. Individual sensor velocities can be viewed using the Diagnostics submenu.	Alarm Status is available at BACnet Objects and Modbus Registers. Refer to BACnet Objects List and Modbus Register Map for additional detail.
HIGH ALARM (Average Alarm)	Display alternates between **HIGH ALARM** (then any other alarms) and actual reading for 2 seconds each.		
TROUBLE ! (Trouble Alarm)	Display indicates TROUBLE ! (Refer to DIAGNOSTIC menu to obtain a brief description of the error and any other alarms).		

TM_GTx116_R9A

GTC/GTM116 - ANALOG OUTPUT TYPE SELECTION AND SETUP

The analog output signal type at OUT1 (airflow) and OUT2 (temperature/alarm) can be set for mA or VDC output by setting switches SW1/SW2 (Figure 8) and by selecting the 4-20mA, 0-5VDC or 0-10VDC ranges in ANALOG OUT sub menu options *AO1 RNGE= / *AO2 RNGE= settings (Appendix B). The transmitter is shipped from the factory with SW1/SW2 and Setup menu options *AO1 RNGE= and *AO2 RNGE= set for 4-20mA.

GTC/GTM116 - Converting Analog Output Signal Values to Airflow and Temperature

Table 7 lists specific conversion equations for analog voltage or current output options.

Table 6. GTC/GTM116 Converting Analog Output Values to Airflow/Temperature

When OUTPUT 1 is Configured as Linear Airflow (FPM, MPS):

ANALOG OUTPUT SCALING AND TYPE			
TO CONVERT TO	0-10 VDC	0-5 VDC	4-20 mA
Airflow (FPM, MPS)	Output Voltage/10 x FS1	Output Voltage/5 x FS1	(Output Current-4)/16 x FS1
Airflow (CFM)	Area (SQF) x Output/10 x FS1	Area (SQF) x Output/5 x FS1	Area (SQF) x (Output - 4)/16 x FS1
Airflow (LPS)	Area (SQM) x Output/10 x FS1 x 1000	Area (SQM) x Output/5 x FS1 x 1000	Area (SQM) x (Output - 4)/16 x FS1 x 1000

When OUTPUT 1 is Configured as Volumetric Airflow (CFM, LPS):

ANALOG OUTPUT SCALING AND TYPE			
TO CONVERT TO	0-10 VDC	0-5 VDC	4-20 mA
Airflow (CFM, LPS)	Output Voltage/10 x FS1	Output Voltage/5 x FS1	(Output Current - 4)/16 x FS1

When OUTPUT 2 is Configured as Temperature (°F, °C):

ANALOG OUTPUT SCALING AND TYPE			
TO CONVERT TO	0-10 VDC	0-5 VDC	4-20 mA
Temp (°F, °C)	Output Voltage/10 x (FS2-MS2) +MS2	Output Voltage/5 x (FS2-MS2) +MS2	(Output Current - 4)/16 x (FS2-MS2) +MS2

NOTES:

- FS1 is AO1 full scale analog output value from ANALOG OUT MENU.
- FS2 is AO2 full scale analog output value from ANALOG OUT MENU.
- MS2 is AO2 minimum scale analog output value from ANALOG OUT MENU.

GTC/GTM116 - OUTPUT TEST - Sending a Test Output Signal to the Host Control System

A test output signal between 0 and 100% of the full scale output (4-20 mA or 0-5VDC/0-10VDC) can be provided by the GTC/GTM116 transmitter to verify proper conversion of the output signals from the transmitter at the host control system. To set a fixed output signal for airflow and temperature, navigate to the OUTPUT TEST submenu in the TOOLS menu. OUT1 and OUT2 tests are independently accessed, and the output will maintain the % selected until the “ESC” button is pressed and normal operation resumes.

TM_GTX116_P09A

GTC116 - TRANSMITTER SETUP FOR RS-485 NETWORK OPERATION

For RS-485 operation, network connections are made on the GTC116 Combination board as shown in Figure 8, and set up is as follows. Network protocol, MS/TP address, device instance number and baud rate options are all selected within the NETWORK section of SETUP menu shown in Appendix B.

GTC116 - RS-485 Network Options and Communications Menu Settings

The transmitter is shipped from the factory with the protocol set for **BACnet MS/TP Master, address 2, MS/TP Device ID 2, Baud rate of 76,800 and no termination**. Initial RS-485 communications settings are accomplished within the GTC116 NETWORK sub menu shown in Appendix B. Termination is set up by the TERM DIP switch SW3 located on the Combination card shown in Figure 8.

GTC116 - Setting Transmitter Termination for RS-485 Network

The GTC116 is shipped with the Termination switch set for No termination, which is the recommended setting for devices installed on the network bus anywhere EXCEPT at the ends of the bus/segment. **EBTRON** recommends the following termination strategy for devices connected at the ends of the network bus/segment:

NOTE:

The device at one end of the network should be terminated with “End of Line” (or 120 ohm standard) termination, and the device at the other end should be terminated with “Fail Safe Bias” termination. This method will provide proper network termination and will ensure that the bus is in a known state during idle-line conditions (when no devices are driving the bus). **EBTRON** GTC116 transmitters include all three termination options for “No Termination”, “End of Line” (standard 120 ohm) or “Fail-safe Bias” (recommended at one end of the bus). Termination is selected by setting the TERMINATION DIP switch SW3” (Figure 8) on the Combination board.



Check the network/network segment to ensure that only one device is terminated with either of these methods. If multiple devices are terminated as described above, network segment operation will be adversely affected.

GTC116 - Setting RS-485 Network Protocol

Transmitter protocol can be set for BACnet MS/TP or MODBUS as shown in the NETWORK submenu (Appendix B). Tables 8 and 9 list the specific features of each protocol.

GTC116 - Setting Transmitter Address

The GTC116 is factory set to an address of 2. Each transmitter must be assigned a unique address between 0 and 127 for BACnet or 1 and 247 for Modbus prior to connecting it to the network. Set the address in the NETWORK submenu (Appendix B).

GTC116 - Setting Baud Rate

The GTC116 transmitter default baud rate for BACnet MS/TP is 76,800 and for MODBUS is 19,200. Baud rate can be configured in the NETWORK sub menu (Appendix B).

GTC116 - Setting Modbus Parity

When using Modbus communications protocol, Parity can be changed in the NETWORK submenu. Parity can be set for Even (default), Odd, None 1 (with 1 stop bit), or None 2 (with 2 stop bits).

GTC116 - Setting BACnet Device Instance Number

When using BACnet communications protocol, the factory default Device Instance Number is 2. Device Instance Number can be set as shown in the NETWORK submenu. Device Instance Number can also be changed to any number between 0 and 4,194,302 by writing to the Device Object's Object Identifier Property over the network.

GTC116 - Resetting Communications Options to Factory Default Values

Communications options can be reset to factory default values (asterisk) * values using the GTC116 RESET NET menu option as shown in Appendix B.

GTM116 - TRANSMITTER SETUP FOR ETHERNET NETWORK OPERATION

An RJ45 network connector is provided on the GTM116 Ethernet/Analog combination board as shown in Figure 9. The user can manually select network protocol (BACnet/IP or BACnet Ethernet - MODBUS TCP is always enabled), IP address and device instance number, or can set the GTM116 to automatically configure itself when used on a network/segment with a DHCP server. By default, the DHCP setting is OFF (***DHCP=OFF**) for manual device configuration, with BACnet IP protocol (**BAC MODE=IP**), a static **IP address** of **10.0.0.100**, a subnet **mask** of **255.255.255.0**, and with **gateway** set for **10.0.0.10**. These values can be changed within the NETWORK sub menu (Appendix B) as described below.

When IP configuration is complete, confirm IP communications locally by “pinging” the assigned GTM116 IP address and observing 5 rapid blinks of the **ACTIVITY** LED (Figure 9).

GTM116 - Selecting Static or Dynamic IP Settings

For automated device configuration on a network/segment with a properly operating DHCP server, set ***DHCP=ON** as shown in Appendix B. Then, set ***BAC MODE=** for BACnet/IP (factory default) or BACnet Ethernet operation, and set ***DI=** device instance number (factory default=2) as described below. No additional device configuration is required.

For manual device configuration of the GTM116, set menu item ***DHCP=OFF** (factory default) as shown in Appendix B. When manually changing IP settings (***DHCP=OFF**), the display will blink the 3-digit address segment that is under change. Change the blinking segment by pressing the UP or DOWN buttons to arrive at the desired segment setting. Depress the ENTER key to set this segment and to move the blinking cursor to the next (right) segment. Repeat this until the last segment has been selected, and then depress ENTER to store the new address setting.

GTM116 - Setting Ethernet Transmitter IP Address

The GTM116 is factory set with an IP address of **10.0.0.100**. Each transmitter must be assigned a unique address on the network/segment it is connected to. To change the IP address, navigate to the ***IP=10.0.0** menu item as shown in Appendix B and set segments as previously described. (See note above regarding ***DHCP=OFF**).

GTM116 - Setting Subnet Mask

To change this value, navigate to the ***MASK=255.2...** menu item as shown in Appendix B, and set new segment values as previously described. (See note above regarding ***DHCP=OFF**).

GTM116 - Setting Gateway IP

To change this value, navigate to the ***GATE=10.0.0...** menu item as shown in Appendix B, and set new segment values as previously described. (See note above regarding ***DHCP=OFF**).

GTM116 - Setting BACnet Protocol Mode

The GTM116 is factory set with ***BAC MODE=IP** for BACnet IP protocol operation. This menu item can be changed to ***BAC MODE=ETH** for BACnet Ethernet protocol as shown in Appendix B. Tables 7, 8 and 9 provide details of TCP/IP, BACnet Objects and Modbus Register Maps respectively. Note that Modbus IP is always enabled regardless of *BAC MODE setting.

NOTE:

For BACnet IP operation, use port 47808. For Modbus TCP operation, use port 502. Modbus IP is always enabled regardless of the *BAC MODE setting.

GTM116 - Setting Device Instance Number

The GTM116 is factory set with a Device Instance Number of 2 (***DI=2**). The Device Instance Number can be set to any value between 0 and 4194302 as shown in Appendix B. The Device Instance Number can also be changed by writing to the Device Object's Object Identifier Property over the network.

GTM116 - Resetting Communications Options to Factory Default Values

Communications options can be reset to factory default values (asterisk) * values using the GTM116 RESET NET menu option as shown in Appendix B.

GTM116 - ETHERNET WIRING CONNECTIONS

Ensure that the transmitter network settings have been properly set up as previously described. Ensure that the power switch is in the "OFF" position. Connect the 10/100 base-T ethernet connection (RJ45) to the female connector on the output card as shown in Figure 9.

Tables 8 and 9 list the specific values provided for BACnet and Modbus communication protocols.

TCP/IP

http://10.0.0.100
(or your custom IP address)

Table 7. GTM116 TCP/IP Example

GTM Data	
Parameter	Value
Flow	3094
Temperature	89

Table 8. GTx116 BACnet Object List

Analog Inputs				Analog Values			
Type, ID	Name	Default Units		AV, 1	Area	sq.ft.	
Device	GTx116		x= C for RS-485 x= M for Ethernet	AV, 2	Traverse Data Status		0=None, 1=Flow, 2=Temp, 3=Both
AI, 1	Average Flow	CFM		AV, 3	Flow Traverse	FPM	
AI, 2	Average Temperature	°F		↕	↕	↕	
AI, 3	Alarm Status			AV, 18	Flow Traverse	FPM	
				AV, 19	Temperature Traverse	°F	
				↕	↕	↕	
				AV, 34	Temperature Traverse	°F	
 <p>BACnet MS/TP</p> <p>NOTE: For GTM116 BACnet IP operation, use port 47808.</p>				Notes:			
				1. Flow and Temp traverse must be enabled through AV2. 2. User Executed Services Supported: Subscribe COV, Read Property, Write Property, Device Communication Control, Who-Is.			

Table 9. GTx116 Modbus Register Map

Modbus		Function	Address	Type	Units	Description	Range/Value
Modbus RTU for GTC116	Modbus TCP for GTM116	2	10001	boolean		Trouble Status	0:OK, 1:Trbl
		4	30001-30002	float	FPM	Average Airflow	0 to 15,000
		4	30003-30004	float	°F	Average Temperature	-20 to 160
		4	30005	word		Number of Inserts	0 to 16
		4	30007	word		Alarm Status	0: No alarm 1: High Alarm 2: Low Alarm 3: Both
		4	30008	word		Connector C1 Sensors	0 to 8
		4	30009	word		Connector C2 Sensors	0 to 8
		4	30010	word		Connector C3 Sensors	0 to 8
		4	30011	word		Connector C4 Sensors	0 to 8
		4	30012-30043	float	FPM	Airflow Flow Traverse	0 to 15,000
			30012-30013			Insert 1 Flow	
	30042-30043			Insert 16 Flow			
4	30044-30075	float	°F	Temperature Traverse	-20 to 160		
	30044-30045			Insert 1 Temp			
	30074-30075			Insert 16 Temp			
4	30076-30077	float	Sq.Ft.	Area	0 to 100		
4	300202	word		Float word order	0: high word first; 1: low word first		

NOTE: For GTM116 Modbus operation, use port 502. Modbus IP is always enabled regardless of *BAC MODE setting.

TM_GTx116_P9A

GTL116 - LONWORKS TRANSMITTER SETUP

The GTL116 includes a full featured LonWorks compatible interface. The **EBTRON** LonWorks output card (part number 800-5030) plugs directly onto the GTL116 main circuit board as shown in Figure 11. It includes a high speed FTT-10A, 78k baud Free Topology transceiver interface that is relatively insensitive to network wiring topology. The GTL116 may be pre-configured using the **EBTRON_116.XIF** file available for download at:

http://www.ebtron.com/downloads/EBTRON_116.XIF, or configured at installation via direct LonWorks parameter upload from the GTL116 transmitter. A service push-button and LED are provided for standard installation. A “Wink” LED is provided for easy device identification. An “Activity” LED and separate transmit and receive “TX” and “RX” provide visual indication of transmitter and communication status. The “Activity” LED normally flashes on for 1 second, off for 1 second when the card is commissioned and online, and remains illuminated constantly if there is an error

To wire the output signal, slide the cover plate up and off of the enclosure. Ensure that the power switch is in the “OFF” position. Connect network cables to the small, three position output terminal labeled “OUTPUT” on the upper left hand side of the main circuit board (shown below) at terminals 1 and 2 only.

GTL116 - LONWORKS NETWORK CONNECTIONS

Connect the transmitter output to the LonWorks bus in a "daisy-chain" configuration using Lonworks approved cable. The transmitter provides an output that is isolated from the main power input. Connect the LonWorks cable at the “OUTPUT” terminal block as follows:

OUTPUT TERMINAL	SIGNAL DESCRIPTION
1	NET+
2	NET-
COM	COMMON (NOT USED)

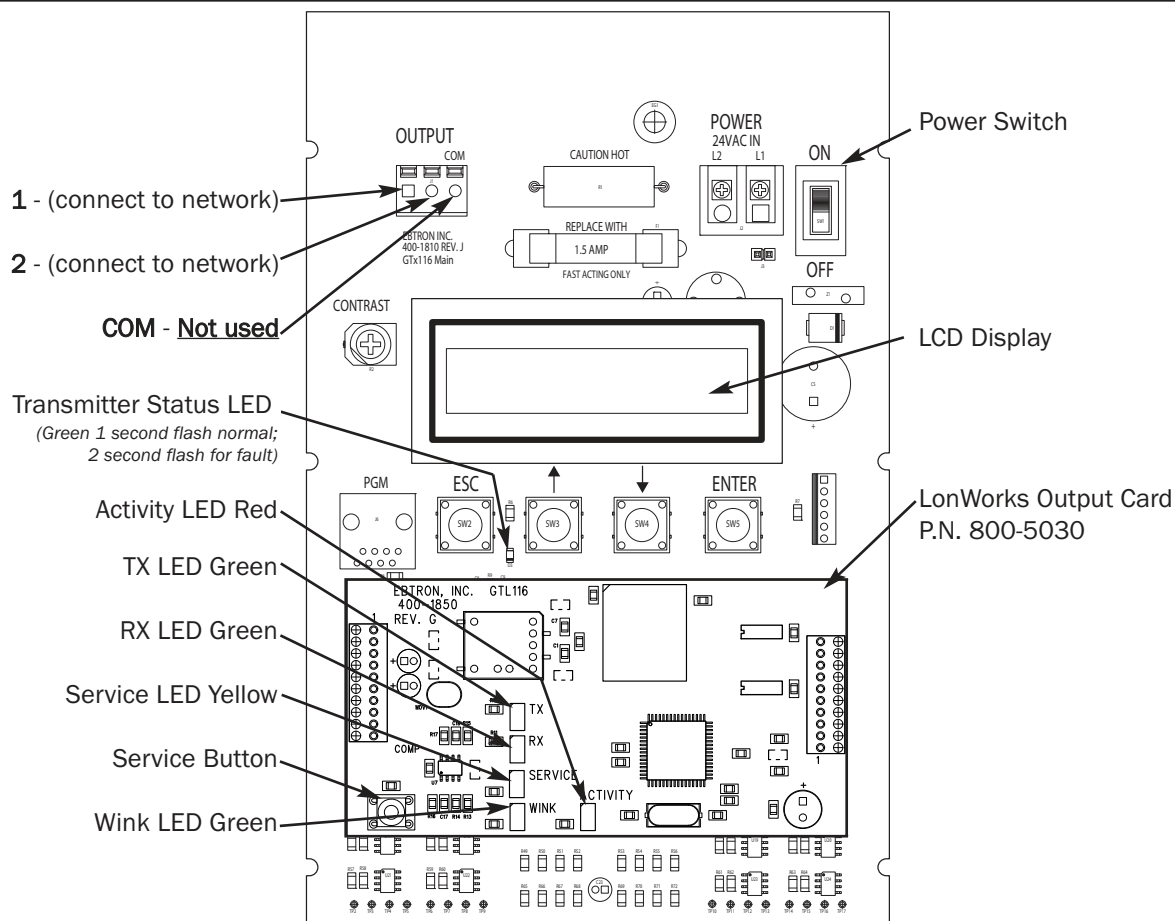

Figure 11. GTL116 LonWorks Transmitter Interior Detail

GTL116 - LONWORKS INTERFACE

Introduction

The Ebtron LonWorks interface adapter is designed to provide an output capability for connection to an Echelon LonWorks based network. Two basic function blocks are provided. These include a node object and a gtx116 function block.

The node object is used for overhead activities on the LonWorks bus. This object is of little interest to the end user.

The gtx116 function block contains a set of network variables and configuration properties that allow the end user to monitor various parameters related to airflow, pressure, and temperature that are generated by the transmitter.

Basic Description

The LonWorks protocol is based on "network variable objects"("nvo"). Each device on the network communicates with other devices by "connecting" to the variables of the device it wishes to monitor. These variables consist primarily of pre-defined types that are part of the network specification.

Additionally, a special class of network properties is defined to allow the configuration of various parameters within a device. These are intended to control the basic operation of a device.

All network variables are defined in terms of "SNVT_xxx". SNVT is an acronym for Standard Network Variable Type. "xxx" is a descriptive phrase that relates to the units used by the parameter represented by the variable. All of the variables described below are always visible on the network; however, some variables are meaningful only with certain types of sensors attached to the transmitter. Tables 10 through 16 describe each of the variables used and the configuration properties for each.

All configuration properties are defined in terms of "SCPTxxx". SCPT is an acronym for Standard Configuration Property Type. There are configuration properties that apply to multiple objects, but may not be listed directly under them when viewed on the network. Check the "applies to" tag in the description for the configuration property in the following sections.

NOTE

Units shown are default values and, depending on software used, may be set automatically by location.

GTL116 - VELOCITY AND FLOW VARIABLES CONFIGURATION

This section details the air flow and air velocity variables and how the configuration properties relate to them.

Velocity and Flow Variables

Table 10. GTL116 LonWorks Node Velocity and Flow Variables

Air Flow Sensor Objects					
Variable Name	Variable Type	Measurement	Type Category	Type Resolution	Units
nvoAirVel	SNVT_speed_mil	Linear Velocity	Unsigned Long	0.001	Meters/second
nvoAirFlow	SNVT_flow	Flow Volume	Unsigned Long	1	Liters/sec
nvoAirFlowFl	SNVT_flow_f	Flow Volume	Floating Point	n/a	Liters/sec



For the “nvoAirFlow” and “nvoAirFlowFl” variables to be meaningful, the ductArea configuration property must be set.

nvoAirVel (SNVT_speed_mil - Air Velocity)

This variable provides simple linear airflow in meters/second.

nvoAirFlow (SNVT_flow - Airflow)

This variable provides volumetric airflow in liters/second. For this variable to be meaningful, the ductArea configuration property must be set.

nvoAirFlowFl (SNVT_flow_f - Airflow Float)

This variable provides volumetric airflow in liters/second. For this variable to be meaningful the ductArea configuration property must be set.

Velocity and Flow Configuration Properties

Table 11. GTL116 LonWorks Node Velocity and Flow Configuration Properties

Air Flow Sensor Configuration Properties					
<i>nvoAirVel</i>	SCPTmaxSendTime	Time	Signed Long	0.1	Seconds
<i>nvoAirVel</i>	SCPTminSendTime	Time	Signed Long	0.1	Seconds
<i>nvoAirVel</i>	SCPTminDelta	Linear Velocity	Unsigned Long	0.001	Meters/second
<i>nvoAirFlow</i>	SCPTductArea	Area	Unsigned Long	0.0002	Square Meters

nvoAirVel (SCPTmaxSendTime - Maximum Time Between Updates)

This configuration property sets the maximum time to elapse between updates to the network for velocity and flow to occur.

nvoAirVel (SCPTminSendTime - Minimum Time Before Updates)

This configuration property sets the minimum time to elapse before an update to the network for velocity and flow may be sent. This configuration property takes priority over **maxSendTime** and **sndDelta**.

nvoAirVel (SCPTsndDelta - Minimum Change for Update)

This configuration property sets the minimum change in velocity that will cause an update of flow and velocity to the network. The change is only checked for in velocity, and when the minimum is reached updates will occur for nvoVel, nvoFlow, and nvoFlowFl.

nvoAirFlow (SCPTductArea - Duct Area for Air Flow Calculation)

This configuration property sets the duct area to be used in flow calculations. Note that this variable must be set to a non-zero value to get flow information.

GTL116 - AREA INPUT VARIABLE

This section details the network input variable area.

Area Input Variable

Table 12. GTL116 LonWorks Area Input Variable

Area Object					
Variable Name	Variable Type	Measurement	Type Category	Type Resolution	Units
nviArea	SNVT_area	Area	Unsigned Long	0.0002	Square Meters

nviArea (SNVT_area – Duct Area for Air Flow Calculation)

This network input sets the duct area to be used in flow calculations. This variable is essentially a copy of nvoAirFlow:SCPTductArea; only one of these inputs needs to be configured before using nvoAirFlow or nvoAirFlowFI.

GTL116 - PRESSURE VARIABLES AND CONFIGURATION

This section details the pressure variables and how the configuration properties relate to them.

Pressure Variables

Table 13. GTL116 LonWorks Node Pressure Variables

Dynamic Pressure Sensor Object					
Variable Name	SNVT	Measurement	Type Category	Type Resolution	Units
nvoPrecisePres	SNVT_press_p	Pressure	Signed Long	0.00001	PA
nvoFloatPres	SNVT_press_f	Pressure	Floating Point	n/a	PA

nvoPrecisePres (SNVT_press_p - Airflow Pressure)

This variable provides air pressure in Pascal. For this variable to be meaningful a bleed sensor must be attached to the transmitter.

nvoFloatPres (SNVT_press_f - Airflow Pressure Float)

This variable provides air pressure in Pascal. For this variable to be meaningful a bleed sensor must be attached to the transmitter.

Pressure Configuration Properties

Table 14. GTL116 LonWorks Node Pressure Configuration

Dynamic Pressure Sensor Configuration Properties					
nvoPrecisePres	SCPTmaxSendTime	Time	Signed Long	0.1	Seconds
nvoPrecisePres	SCPTminSendTime	Time	Signed Long	0.1	Seconds
nvoPrecisePres	SCPTsndDelta	Pressure	Signed Long	0.0001	PA

nvoPrecisePres (SCPTmaxSendTime - Maximum Time Between Updates)

This configuration property sets the maximum time to elapse between updates to the network for pressure to occur.

nvoPrecisePres (SCPTminSendTime - Minimum Time Before Updates)

This configuration property sets the minimum time to elapse before an update to the network for pressure may be sent. This configuration property takes priority over maxSendTime and sndDelta.

nvoPrecisePres (SCPTsndDelta - Minimum Change for Update)

This configuration property sets the minimum change in pressure that will cause an update for pressure to the network. When this change is met both nvoPrecisePres and nvoFloatPres will be updated on the network.

Temperature Variables and Configuration Properties

This section details the temperature variable and how the configuration properties that relate to it.

Table 15. GTL116 LonWorks Node Temperature Variable

Temperature Sensor Object					
Variable Name	SNVT	Measurement	Type Category	Type Resolution	Units
nvoTemp	SNVT_temp_p	Temperature	Signed Long	0.01	Degrees C

nvoTemp (SNVT_temp_p - Temperature Variable)

This network variable provides temperature in degrees Celsius.

Table 16. GTL116 LonWorks Node Temperature Variable

Temperature Sensor Configuration Properties					
<i>nvoTemp</i>	SCPTmaxSendTime	Time	Signed Long	0.1	Seconds
<i>nvoTemp</i>	SCPTminDeltaTemp	Temperature	Signed Long	0.001	Degrees C
<i>nvoTemp</i>	SCPTminSendTime	Time	Signed Long	0.01	Seconds

Temperature Configuration Properties

nvoTemp (SCPTmaxSendTime - Maximum Time Between Updates)

This configuration property sets the maximum time to elapse between updates to the network for temperature to occur.

nvoTemp (SCPTminDeltaTemp - Minimum Change for Update)

This configuration property sets the minimum change in temperature that will cause an update of nvoTemp to the network.

nvoTemp (SCPTminSendTime - Minimum Time Before Updates)

This configuration property sets the minimum time to elapse before an update to the network for temperature may be sent. This configuration property takes priority over maxSendTime and minDeltaTemp.

GTL116 - DEFAULT DELTA VALUES

The default Delta values determine when updates are sent from the transmitter to the network. The Delta values are set with a large factory default value to prevent any undesired messages from being sent to the network. Refer to the preceding paragraphs for description and configuration of the Delta values.

EB-Link WIRELESS INFRARED COMMUNICATIONS OPTION

The **EB-Link** wireless infrared communications option is ideal for air balance contractors, engineers, building owners and/or contractors who desire fast and accurate measurement without additional interfacing. Individual and average sensor airflow(s) and temperature(s) from GTx116 transmitters equipped with the **EB-Link** option can be instantly transferred to the new **EB-Link Reader** model ELR-1 or to a Palm[®] or Microsoft[®] Windows Mobile[®] operating system PDA. This method reduces the data acquisition time and sampling error inherent with hand held measurements. The data can then be transferred to your PC for review, update or analysis.

In addition, a Setup-Upload feature (available only with the PDA software version) permits rapid transfer of preset transmitter setup configuration to another **EB-Link** equipped GTx116 transmitter. This is especially useful when multiple transmitters are to be set up or modified.

Real-time duct flow/temperature traverses can be accomplished quickly and easily using the GTx116 transmitter equipped with the **EB-Link** option. Individual airflow and temperature data can be returned directly to your **EB-Link Reader** or PDA (using Palm[®] or Microsoft[®] Windows Mobile[®] operating system). The data can also be returned over BACnet or Modbus when probes are connected to a type GTC116/GTM116 networked transmitter.

This innovative feature is ideal for balancers and commissioning agents that desire “on-the-fly” airflow and temperature traverses. The advantages of using permanently installed GP1 probes include nearly instantaneous traverse data (no sampling error over time), accurate and repeatable measurement and simple report generation using the Microsoft[®] Excel[®] spreadsheet provided by **EBTRON**. Performing duct traverses with permanently mounted EBTRON airflow probes eliminates the requirement to make additional sampling holes in the duct, and reduces the need to carry around the job site cumbersome equipment and ladders to accomplish them.

EB-Link Card Installation



CAUTION: Observe all electrostatic Discharge (ESD) handling precautions. Do not touch internal components. Failure to observe ESD precautions can cause damage to components.



CAUTION: Turn the transmitter “POWER” switch to the “OFF” position before installing the **EB-Link** card. Failure to do so can cause damage to the **EB-Link** card and/or the transmitter.

The **EB-Link** card must be installed on the GTx116 main board in order to access sensor data with your PDA. If the **EB-Link** card is ordered separately from the transmitter, it should be installed after the transmitter is mounted.

To install the **EB-Link** option card, slide the cover up and off of the transmitter enclosure. Turn the power switch, SW1, to the “OFF” position on the transmitter main circuit board. Observe ESD precautions when handling and installing the **EB-Link** card. Touch a grounded object, such as a metal duct, before removing the **EB-Link** card from the anti-static package. Remove the **EB-Link** card from the anti-static package, being careful not to touch exposed components or circuit board traces (hold the card by the edges as indicated on left frame of Figure 12). With the components facing in towards the center of the main circuit board, carefully plug the **EB-Link** card into the header connector labeled J5 on the right hand side of the transmitter just below the LCD display (center frame, Figure 12). Do not press on any components. The card should stand on its own when properly installed (right frame of Figure 12).

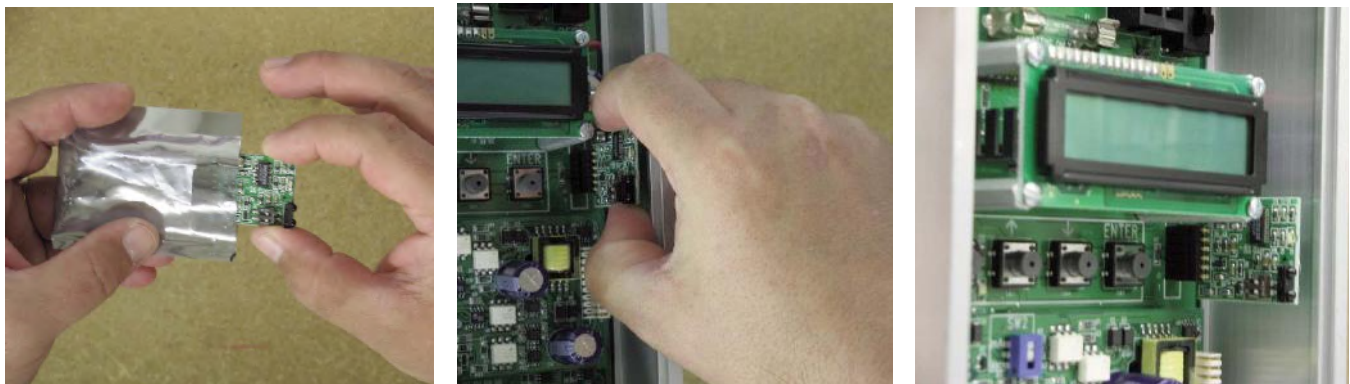

Figure 12. EB-Link Installation Detail

Obtaining and Installing *EB-Link* Software

EB-Link software can be downloaded free of charge at:
http://www.ebtron.com/support_downloads.htm.

Versions are available for the *EB-Link Reader*, or for PDAs (for either the Palm® or Microsoft® Windows Mobile® operating systems) as shown in Figure 13. Figure 14 shows the *EB-Link* in use.

The software includes all of the files required for operation of the *EB-Link Reader* or for PDAs as well as a Microsoft® Excel® spreadsheet for converting the PDA files to a Test and Balance report.

EB-Link Reader Software

The *EB-Link Reader* software is designed for operation on Windows XP (or later) operating systems and permits file management and time synchronization for the *EB-Link Reader*.

The latest version of the *EB-Link Reader* software, as well as installation, operation and descriptions of all *EB-Link Reader* functions are contained in the *EB-Link Reader Technical Documentation* available at the following link:

http://www.ebtron.com/Web_Pdfs/SPSync/Accessory%20Products/EB-LINK%20READER/QSG-EBR-1000.pdf.

EB-Link Software for PDA Devices

The *EB-Link Software for PDA Devices* is designed for operation with PDA devices using the Palm® or Microsoft® Windows Mobile® operating systems. The software includes a Microsoft® Excel® spreadsheet that allows for the pre-configuration, review or modification of GTx116 transmitter setup parameters.

The latest version of the software, as well as installation and descriptions of all *EB-Link* functions are contained in the *readme.txt* file that is provided with the download.

Real-time duct traverses can be accomplished quickly and easily using the GTx116 transmitter equipped with the *EB-Link* option. Individual airflow and temperature data can be returned directly to your PDA (Palm® or Microsoft® Windows Mobile® operating system). Data can also be returned over BACnet or Modbus when probes are connected to a GTC116/GTM116 transmitter.

Real Time Duct Traverses Using *EB-Link*

Simply slide the GTx116 cover up and off of the GTx116 transmitter enclosure and point your *EB-Link Reader* or PDA to the *EB-Link* sensor located just to the right and below the transmitter LCD display as shown in Figure 14 (note: the *EB-Link* card option must be installed). The acquisition of data takes less than 10 seconds to complete. After acquiring data, you can display individual or average airflow and/or temperature data on your *EB-Link Reader* or PDA. Saved data (stored as a comma separated value CSV file) can also be downloaded to your PC for creation of individual test and balance reports using the software of your choice, or with the Microsoft® Excel® spreadsheet that *EBTRON* has included with the PDA software. Note that the traverse sensor data is averaged to provide more stable readings.

Note also that on rectangular ducts, the *EBTRON* Excel® balance report will always show the traverse data starting at the top left position of the duct when viewing from upstream of the flow station, regardless of the orientation of the probes, when the probes are installed as indicated in the configuration diagrams of Figure 10. On round/oval ducts, the balance report will always show traverse data in columns, starting with probe number one.

NOTE



If traverse data is desired, ensure that probes are installed using the mounting convention specified in Figure 10. Proper installation simplifies sensor location decoding during data analysis.

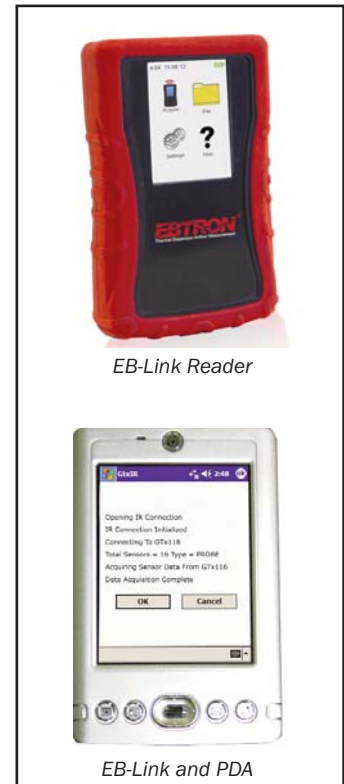

Figure 13. *EB-Link Reader* and PDA Devices



Figure 14. Typical *EB-Link* Data Acquisition

TM_GTx116_R9A

FIELD ADJUSTMENTS

ALTITUDE CORRECTION ADJUSTMENT

The Altitude Correction Adjustment allows for correction of airflow readings at the installed site altitude and more precise readings regardless on installed altitude. Refer to the SETUP MENU of Appendix B for the *ALT= menu item, and set this value to the installation altitude. This adjustment is only necessary when AIRFLOW=ACT.

ADJUSTING THE LOW LIMIT CUTOFF

The low limit cutoff forces the output signal for the airflow rate to zero whenever the airflow rate calculated falls below the specified Low Limit value. This feature is useful on outside air intakes that often indicate false airflow rates, induced by transient wind gusts or when the intake damper is closed and there is no net flow across the damper. Readings of 100 FPM or more are not uncommon on many outside air intake applications when the intake damper is closed and are a result of air movement in the intake plenum (not a malfunction in the airflow measuring device). Setting the low limit to a value significantly below the control setpoint and higher than the threshold flow for false wind readings simplifies control and interpretation of the airflow rate signal on many applications.

To set the low limit cutoff, enter the Setup menu and set “*LLIMIT={desired value in FPM (MPS in SI units)}” as shown in Appendix B.



Fluctuations in the airflow output signal are normal. **EBTRON's** laboratory research indicates that dampening true fluctuations will result in poor control and a larger dead-band of operation.

FACTORY CALIBRATION ADJUSTMENTS

The factory calibration should not require adjustment if the sensor probes are installed in accordance with published installation guidelines. However, some installations may not meet placement guidelines or commissioning requirements may dictate field adjustment. Field adjustment may improve the “installed accuracy” of GTx116 systems when determining volumetric flow rates. Only the Output 1 signal, airflow rate, can be adjusted. Ensure that the reference device and technique used to determine the airflow rate in the field are suitable for such measurement. Select a location that is acceptable for the device being used as the reference, recognizing that this may not be the same location where the **EBTRON** airflow station is installed. The inherent accuracy of field measurement will not be better than $\pm 5\%$ of reading and can often exceed $\pm 10\%$. Do not adjust the output of the GTx116 if the difference between the transmitter and the field measurement is less than 10%.

Field Adjustment Wizard - AUTOMATED FIELD ADJUSTMENT

Overview of the Field Adjustment Wizard

The simple to use Field Adjustment Wizard provides a one or two point automated menu driven field adjustment to factory calibration of the OUTPUT 1 airflow rate signal.

Engaging and Using the Field Adjustment Wizard

Use Appendix B to navigate to the FIELD ADJUST submenu. Appendix B provides details of the FIELD ADJUST menu and how to use it in applications for one or two point automated field adjustment. If you wish to disable the FIELD ADJUST setting, navigate to the ADJUSTMENTS submenu and set FLOW ADJ=OFF.

MANUAL ADJUSTMENT OF FACTORY OFFSET/GAIN CALIBRATION

If you prefer, you can instead perform a manual adjustment at one or two points. The GTx116 firmware can be adjusted for Output 1 signal “gain” and “offset”. To adjust the output signal “gain”, the “FLOW ADJ” override must be set to “*FLOW ADJ=ON” from the Setup Menu. The adjustments affect both the LCD display and output signal. When “*FLOW ADJ=OFF” is set, adjusting the output signal “offset” and/or “gain” does not affect the transmitter output.

Procedure for 1 Point Field Adjustment

Select an airflow rate that represents a valid operating condition for the system. Set fan speed, dampers and VAV boxes to a fixed speed or position when measurements are taken. Complete the following worksheet to determine the gain setting to be set on the transmitter.

1. Enter the setup menu and set “*FLOW ADJ=OFF”. This is the factory default setting and disables any adjustments, returning the unit to its original factory calibration.
2. _____ Record the transmitter output by taking the visual reading from the transmitter LCD. Readings can be taken by the host controls if the output signal conversion has been confirmed. Time averaging the data will improve field recalibration.
3. _____ Record the reference reading. Make sure that the unit of measure (FPM, CFM) is identical for both the transmitter and the reference. If the unit of measure is velocity (FPM), make sure that the reference airflow measurement was corrected for the area where the measurement was taken.
4. _____ Calculate the gain factor (m): **$m = \text{line 3} / \text{line 2}$** .
5. Enter the setup menu and set “*FLOW ADJ=ON”.
6. Set “*GAIN={value calculated in line 4}”.
7. Confirm that “*OFF=0.00”.
8. Press the “ESC” button until you return to the normal operating mode. Field adjustment is complete.

Procedure for 2 Point Field Adjustment

Select the minimum and maximum airflow rate that the airflow station will encounter as a valid operating condition for the system. Set fan speed, dampers and VAV boxes to a fixed speed or position when measurements are taken. Complete the following worksheet to determine the gain and offset settings to be set on the transmitter. Measurement units can be in either FPM or CFM, but they need to be the same between transmitter and reference. When using FPM, ensure that area for both measurements is the same.

1. Enter the setup menu and set “*FLOW ADJ=OFF”. This is the factory default setting and disables any adjustments, returning the unit to its original factory calibration. **OBSERVE AND APPLY MEASUREMENT UNITS FOR CONSISTENCY BETWEEN TRANSMITTER AND REFERENCE.**
 2. Set the minimum airflow rate.
 3. _____ Record the transmitter airflow rate by taking the visual reading from the transmitter LCD. Readings can be taken by the host controls if the output signal conversion has been confirmed. Time averaging the data will improve field recalibration.
 4. _____ Record the reference airflow rate. Make sure that the reference airflow measurement was corrected for the area where the measurement was taken.
 5. Set the maximum airflow rate.
 6. _____ Record the transmitter airflow rate.
 7. _____ Record the reference airflow rate.
 8. _____ Calculate the gain factor (m): **$m = (\text{line 7} - \text{line 4}) / (\text{line 6} - \text{line 3})$** .
 9. _____ Calculate the offset factor (b): **$b = (\text{line 4} - (\text{line 8} \times \text{line 3}))$** .
- If more than 2 points are available, perform a linear regression on the data to determine gain and offset.**
10. Enter the setup menu and set “*FLOW ADJ=ON”.
 11. Set “*GAIN={value calculated in line 8}”.
 12. Set “*OFF={value calculated in line 9}”. Note that OFFSET must be entered in FPM. If measurements were recorded in CFM then values need to be divided by duct area before entering in transmitter.
 13. Press the “ESC” button until you return to the normal operating mode. Field adjustment is complete.

MAINTENANCE

When transmitter and probes are installed in accordance with **EBTRON** guidelines, instrument difficulties are rare. Issues may easily be resolved by viewing Diagnostic data from the Diagnostic Menu (Appendix B) and by proceeding through the following troubleshooting guides (Tables 17 through 21). Customer support is available Monday - Thursday from 8 AM to 5:00 PM, and on Friday from 8AM to 2:30PM ET, at 800-2**EBTRON** (232.8766). **EBTRON** Diagnostic Customer Service forms are available on-line at www.ebtron.com to assist us in accurately diagnosing issues and will greatly expedite their resolution. A sketch of the installation, along with the control sequence of operations is recommended to help us diagnose problems. Fax the information to 843.756.1838 before you call, and have it available when speaking with the Customer Service team. Address all correspondence to the **EBTRON** Customer Service Department. Additional information is also available from your local **EBTRON** representative.

STANDARD LIMITED PARTS WARRANTY

If any **EBTRON** product fails within 36 months from shipment, **EBTRON** will repair/replace the device free of charge as described in the company's warranty contained in **EBTRON's** *TERMS AND CONDITIONS OF SALE*. Defective equipment shall be shipped back to **EBTRON**, freight pre-paid, for analysis.

Table 17. General Troubleshooting (All GTX116 Systems)

Problem	Possible Cause	Remedy
No LCD display indication and the green Transmitter Status LED (D3) on the main circuit board is not illuminated.	Power switch not in the "ON" position.	Move the power switch to the "ON" position.
	Improper supply voltage to the power input terminal block.	Ensure that 24VAC power is connected to L1 and L2 of the POWER terminal block and that the voltage with the power switch in the "ON" position is between 22.8 and 26.4 VAC.
	Blown fuse.	Check power wiring. Ensure that multiple devices wired on a single transformer are wired "in-phase". Replace fuse only with a 1.5 amp, fast-acting fuse after the problem has been identified and corrected.
No LCD display indication and the green Transmitter Status LED (D3) on the main circuit board is flashing.	LCD contrast too low.	Turn "Contrast" potentiometer on the main circuit board "clockwise".
The LCD display is scrambled or there is no LCD display indication after touching the switches, LCD display or circuit board.	Static electricity.	Touch an earth-grounded object, such as a duct, to discharge static electricity then reset the power. Avoid direct contact with the LCD display or circuit board.
The green Transmitter Status LED (D3) on the main circuit board is "ON" but not flashing.	The microprocessor is not running.	Reset 24VAC power by moving the power switch from the "ON" to "OFF" position and then back to the "ON" position.
The green Transmitter Status LED (D3) on the main circuit board is flashing at 1-second intervals.	No problem, normal operation.	No remedy required.
The green Transmitter Status LED (D3) on the main circuit board is flashing at 2-second intervals.	The sensor detection system has detected trouble.	Check sensor probe cable connections. If sensor probe connections look OK and match the number of sensor probes indicated on each probe's hang tag, please call EBTRON's customer service department or visit us at www.ebtron.com .
	Wrong type of sensor probes attached to transmitter.	GTX116 transmitter will only operate with GP1 or GB1 sensors connected.
The transmitter indicates airflow when the HVAC system is not operating.	Sensors are sensitive and can measure very low air velocities. If a reading is indicated, there is airflow present where the airflow measuring station is located.	Do not attempt to adjust zero ("offset"). Doing so will result in an error in airflow measurement. The Low Limit airflow cutoff value can be set to force the output signal to zero.

Table 18. GTC116 and GTM116 - Analog Operation Transmitter Troubleshooting

Problem	Possible Cause	Remedy
No output signal can be measured at the OUTPUT terminal block of the GTC116/GTM116 transmitter.	Output card is not securely mounted on main circuit board.	Turn the transmitter power "OFF", and then press the output card firmly onto main circuit board. Turn the transmitter power back "ON".
	Blown output fuse (output 1 and output 2 are fused and protected independently on GTC116/GTM116 transmitters).	Make sure that power has not been connected to the output terminal block. Correct the problem and replace with 0.125 amp, fast acting fuse only. Make sure that the host control system is not configured for a 2-wire device (no excitation voltage should be present on the signals from the host controls). Correct the problem and replace with 0.125 amp, fast acting fuse only.
	The Low Limit airflow cutoff value is above the actual airflow reading.	Decrease the Low Limit airflow cutoff value in the Setup menu until it is below the actual airflow reading.
The output signal on the GTC116/GTM116 transmitter fluctuates while the flow and/or temperature readings on the LCD are steady.	Electrical interference from other devices is creating noise in the signal wires to the host control system.	The output signal wiring must be shielded. Individually ground one or more of the following points: the signal wire shield at host controls; signal wire shield at the transmitter, or L2 of the power terminal block of the GTC116/GTM116.
	The LCD INTG= value may be greater than the AO1 INTG= value.	Review and verify LCD INTG= and AO1 INTG= settings.
The LCD display does not match the readings indicated by the host control system.	The scaling in the host control system is incorrect, or the AO1/AO2 RNGE= settings are incorrect.	Compare the current configuration of the transmitter with that of the host control system. Compare the minimum and full scale settings for each output by navigating through the Setup menu. Verify AO1/AO2 RNGE= settings

Table 19. GTC116 RS-485 Transmitter Troubleshooting

Problem	Possible Cause	Remedy
The host control system is unable to communicate with the GTC116 transmitter.	Output card is not securely mounted on main circuit board.	Turn the transmitter power "OFF" and press the output card firmly onto main circuit board. Turn the transmitter power back "ON".
	Network signal wiring is not properly connected to the GTC116 transmitter or the host controls.	Verify that the network signal wires from the host controls are connected to the proper terminals of the OUTPUT block. On the GTC116 transmitter NETWORK terminal block, NET+ is for A, NET- is for B and COM for common.
	Network protocol is not properly set on the GTC116.	Set network protocol based on the network requirements and reset transmitter power.
	Network address is not properly set on the GTC116.	Set address based on network requirements and reset transmitter power. The address must be unique for the network.
	Network termination is not properly set on the GTC116.	Set transmitter termination based on network requirements and reset the transmitter power. Refer to Figure 8 of this technical manual for TERMINATION DIP switch settings.
The LCD display does not match the readings indicated by the host control system.	The Area of the GTC116 transmitter does not match that of the host controls.	Compare the value of the Area of the transmitter with that of the host control system and make adjustments to ensure a match.
The returned value for airflow is zero when airflow is indicated on the LCD display of the GTC116 transmitter.	The Low Limit airflow cutoff value is above the actual airflow reading.	Decrease the Low Limit airflow cutoff value in the Setup menu until it is below the actual airflow reading.
The status point from the GTC116 transmitter has a Trouble value.	The sensor detection system has detected one or more malfunctioning or missing sensors.	Check sensor probe cable connections. If sensor probe connections look OK and match the number of sensor probes indicated on each probe's hang tag, please call EBTRON's customer service department or visit us at www.ebtron.com .
	Wrong type of sensor probes attached to transmitter.	GTx116 transmitter will only operate with GP1 or GB1 sensors connected.
There is no value for the differential pressure point.	Differential pressure is only available from transmitters that have EBTRON's Bi-directional Bleed Airflow Sensors connected.	If a differential pressure measurement is required, contact your local EBTRON Representative about EBTRON's Bi-directional Bleed Airflow Sensor.

TM_GTx116_P9A

Table 20. GTM116 Ethernet Transmitter Troubleshooting

Problem	Possible Cause	Remedy
The host control system or web browser is unable to communicate with the GTM116 transmitter.	Verify that power is available to board (ACTIVITY LED is illuminated). If not verify that Output card is securely mounted on main circuit board.	Set transmitter power to "OFF" and press the output card firmly onto main circuit board. Turn the transmitter power back "ON".
	There is no link to the network indicated by the LINK LED on the output card.	The LINK LED indicates a valid connection to the network when it is illuminated. If the LINK LED is not on, verify network cabling and connections between the GTM116 and the network switch or hub. If LINK LED is on, verify that traffic is flowing by observing the TRAFFIC LED. If LINK LED is on, but TRAFFIC LED is not, check for defective network cabling.
	The network protocol has not been properly set on the GTM116.	Set network protocol based on network requirements and reset transmitter power.
	The transmitter address has not been properly set on the GTM116.	Set the address based on your network requirements. Note that each address must be unique for the network.
The LCD display does not match the readings indicated by the host control system.	The area factor in the GTM116 transmitter does not match that of the host controls.	Compare the value of the Area factor of the GTM116 transmitter with that of the host control system and make adjustments to ensure a match.
The returned value for airflow is zero when there is airflow indicated on the LCD display of the GTM116 transmitter.	The Low Limit airflow cutoff value is above the actual airflow reading.	Decrease the Low Limit airflow cutoff value in the Setup menu until it is below the actual airflow reading.
The status register from the GTM116 transmitter has a Trouble value.	The sensor detection system has detected one or more malfunctioning or missing sensors.	Check sensor probe cable connections. If sensor probe connections look OK and match the number of sensor probes indicated on each probe's hang tag, please call EBTRON's customer service department or visit us at www.ebtron.com .
	Wrong type of sensor probes attached to transmitter.	GTx116 transmitter will only operate with GP1 or GB1 sensors connected.
There is no value for the differential pressure point.	Differential pressure is only available from transmitters that have EBTRON's Bi-directional Bleed Airflow Sensors connected.	If a differential pressure measurement is required, contact your local EBTRON Representative about EBTRON's Bi-directional Bleed Airflow Sensor.

Table 21. GTL116 LonWorks Transmitter Troubleshooting

Problem	Possible Cause	Remedy
The host control system is unable to communicate with the GTL116 transmitter.	Output card is not securely mounted on main circuit board.	Turn the transmitter power "OFF" and press the output card firmly onto main circuit board. Turn the transmitter power back "ON".
	The network signal wiring is not properly connected to the GTL116 transmitter or the host controls.	Verify that network cabling from the host controls is connected to the proper terminals of the OUTPUT terminal block on the GTL116 transmitter. Wires should only be connected to positions 1 and 2 on the terminal block.
	The LonWorks network database has not been configured for the GTL116 transmitter.	The LonWorks network database may be pre-configured using the EBTRON_116.XIF file available for download at www.ebtron.com or configured at installation time by direct LonWorks parameter upload from the GTL116 transmitter.
The GTL116 transmitter is not providing values for any of the variables.	The required network configuration variables have not been set.	Certain network configuration variables must be set to enable the LonWorks output card to request data from the GTL116 transmitter. Refer to the GTL116 - LonWorks INTERFACE section of this technical manual for specific GTL116 variables and settings.
There is no value for the differential pressure variables.	Differential pressure is only available from transmitters that have EBTRON's Bi-directional Bleed Airflow Sensors connected.	If a differential pressure measurement is required, contact your local EBTRON Representative about EBTRON's Bi-directional Bleed Airflow Sensor.
The LCD display does not match the readings indicated by the host control system.	The area factor in the GTL116 transmitter does not match that of the host controls.	Compare the value of the Area of the GTL116 transmitter with that of the host control system and make adjustments to ensure a match.
The returned value for airflow is zero when airflow is indicated on the LCD display of the GTL116 transmitter.	The Low Limit airflow cutoff value is above the actual airflow reading.	Decrease the Low Limit airflow cutoff value in the Setup menu until it is below the actual airflow reading.
The status variable from the GTL116 transmitter has a Trouble value.	The sensor detection system has detected one or more malfunctioning or missing sensors.	Check sensor probe cable connections. If sensor probe connections look OK and match the number of sensor probes indicated on each probe's hang tag, please call EBTRON's customer service or visit us at www.ebtron.com .
	Wrong type of sensor probes attached to transmitter.	GTx116 transmitter will only operate with GP1 or GB1 sensors connected.

TM_GT116_R9A

APPENDIX A - WIRING DIAGRAMS

GTC116 Combination Analog/RS-485 Output Transmitter Wiring Diagram

Figure A-1 is a typical wiring diagram for the GTC116 transmitter.

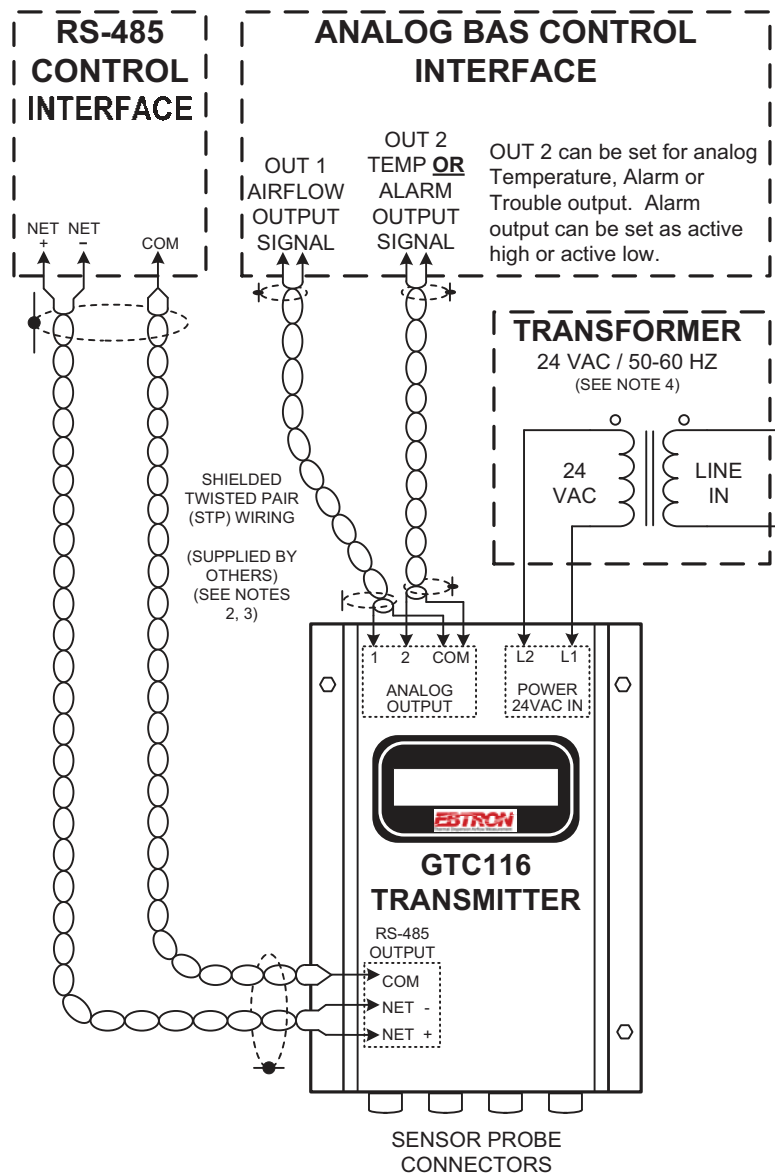

NOTES:

1. OUTPUT 2 CAN BE SET AS TEMPERATURE OR AS AN ALARM. ALARM CAN BE SET AS ACTIVE HIGH OR ACTIVE LOW.
2. CONNECT OUTPUT SIGNAL CABLE DRAINS TO EARTH GROUND AT ONE END OF EACH CABLE ONLY.
3. RS-485 COM CONNECTION MAY USE A SINGLE CONDUCTOR.
4. ON MULTIPLE TRANSMITTER INSTALLATIONS WITH A COMMON 24VAC SOURCE, WIRE 24 VAC POWER IN-PHASE TO THE SAME TERMINALS ON ALL TRANSMITTERS (e.g.: L1 to L1, L2 to L2).

Figure A-1.

Model GTC116 Combination Analog/RS-485 Wiring Diagram

TM_GTX116_P0A

APPENDIX A - WIRING DIAGRAMS (cont'd)

GTM116 Combination Analog/Ethernet Output Transmitter Wiring Diagram

Figure A-2 is a typical wiring diagram for the GTM116 transmitter.

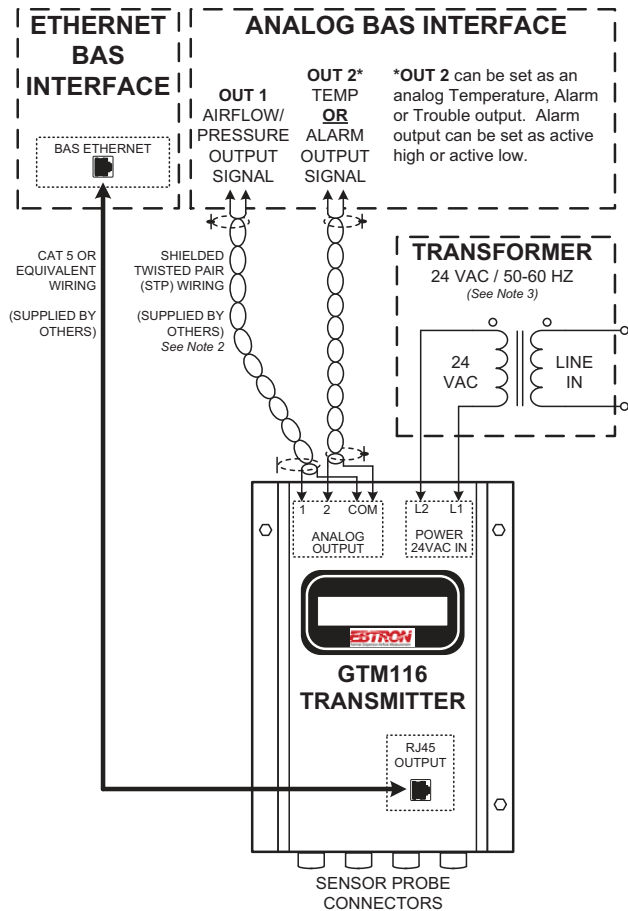

NOTES:

1. OUTPUT 2 CAN BE SET AS TEMPERATURE OR AS AN ALARM. ALARM CAN BE SET AS ACTIVE HIGH OR ACTIVE LOW.
2. CONNECT OUTPUT SIGNAL CABLE DRAINS TO EARTH GROUND AT ONE END OF EACH CABLE ONLY.
3. ON MULTIPLE TRANSMITTER INSTALLATIONS WITH A COMMON 24VAC SOURCE, WIRE 24 VAC POWER IN-PHASE TO THE SAME TERMINALS ON ALL TRANSMITTERS (e.g.: L1 to L1, L2 to L2).

Figure A-2.
Model GTM116
Combination Analog/Ethernet Wiring Diagram

GTL116 LonWorks Output Transmitter Wiring Diagram

Figure A-3 is a typical wiring diagram for the GTL116 transmitter.

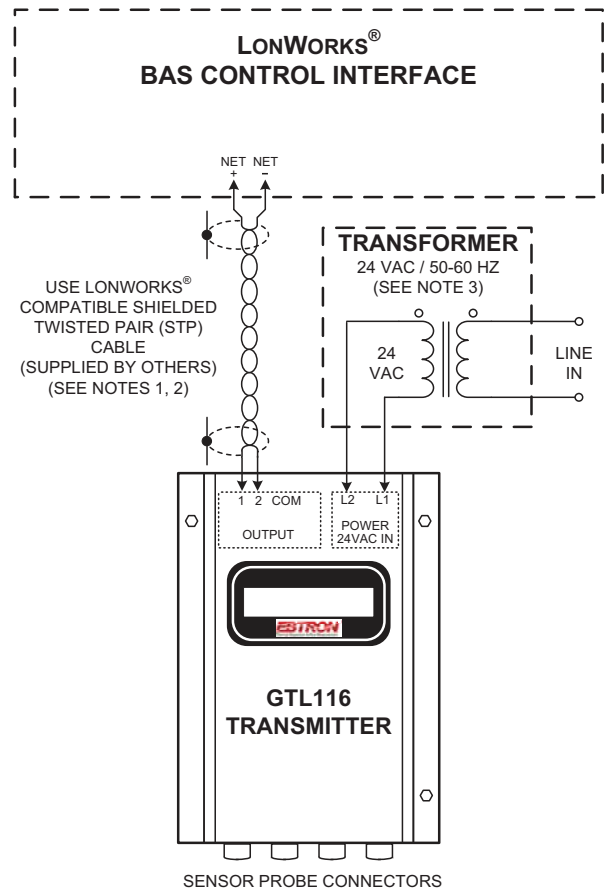

NOTES:

1. REFER TO *LonWorks® FTT-10A Free Topology Transceiver User's Guide* AVAILABLE AT www.echelon.com FOR LONWORKS® NETWORK WIRING SPECIFICATIONS AND TERMINATION REQUIREMENTS.
2. GTL116 CONNECTIONS AT TERMINALS 1 AND 2 (NET + and NET -) ARE NOT POLARITY SENSITIVE, AND THE COM CONNECTION IS NOT USED.
3. ON MULTIPLE GTx116 TRANSMITTER INSTALLATIONS WITH A COMMON 24VAC SOURCE, WIRE 24 VAC CONNECTIONS IN-PHASE TO THE SAME TERMINALS ON ALL TRANSMITTERS (e.g.: L1 to L1, L2 to L2).

Figure A-3.
Model GTL116
LonWorks Wiring Diagram

TM_GTx116_R9A

APPENDIX B - GTx116 SETUP MENUS

SYSTEM OF UNITS MENU

Simultaneously depress/release ENTER + ESC keys during normal operation to select

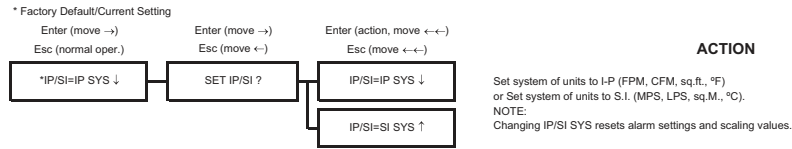
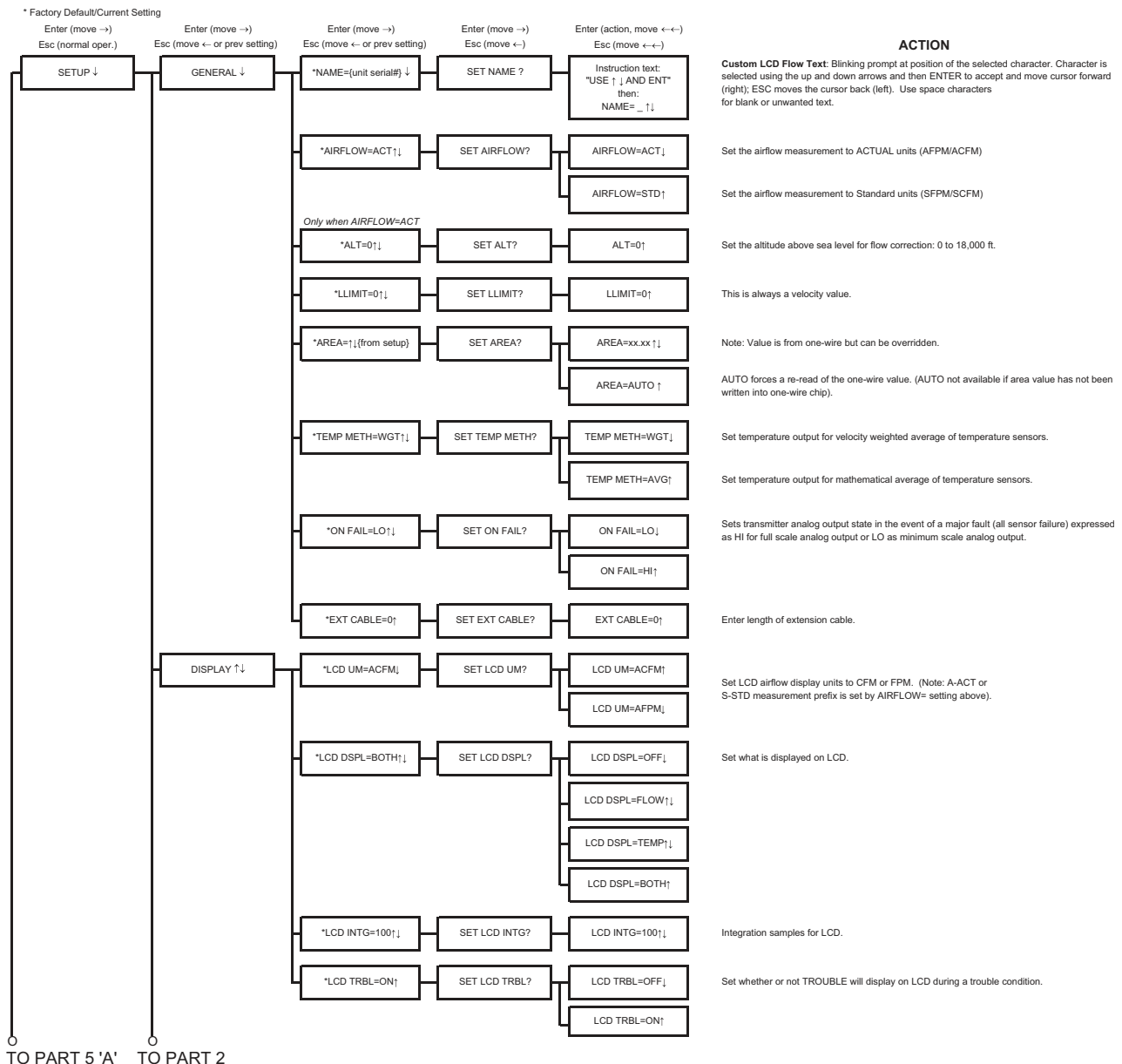

Figure B-1. TM_GTx116 System of Units Menu

TM_GTx116 Setup Menu (PART 1 OF 6)

SETUP MENU

Simultaneously depress/release ↑ + ↓ keys during normal operation to select



TM_GTx116_R9A

Figure B-2. GTx116 Setup Menu

TM_GTx116 Setup Menu (PART 2 OF 6)

FROM PART 1

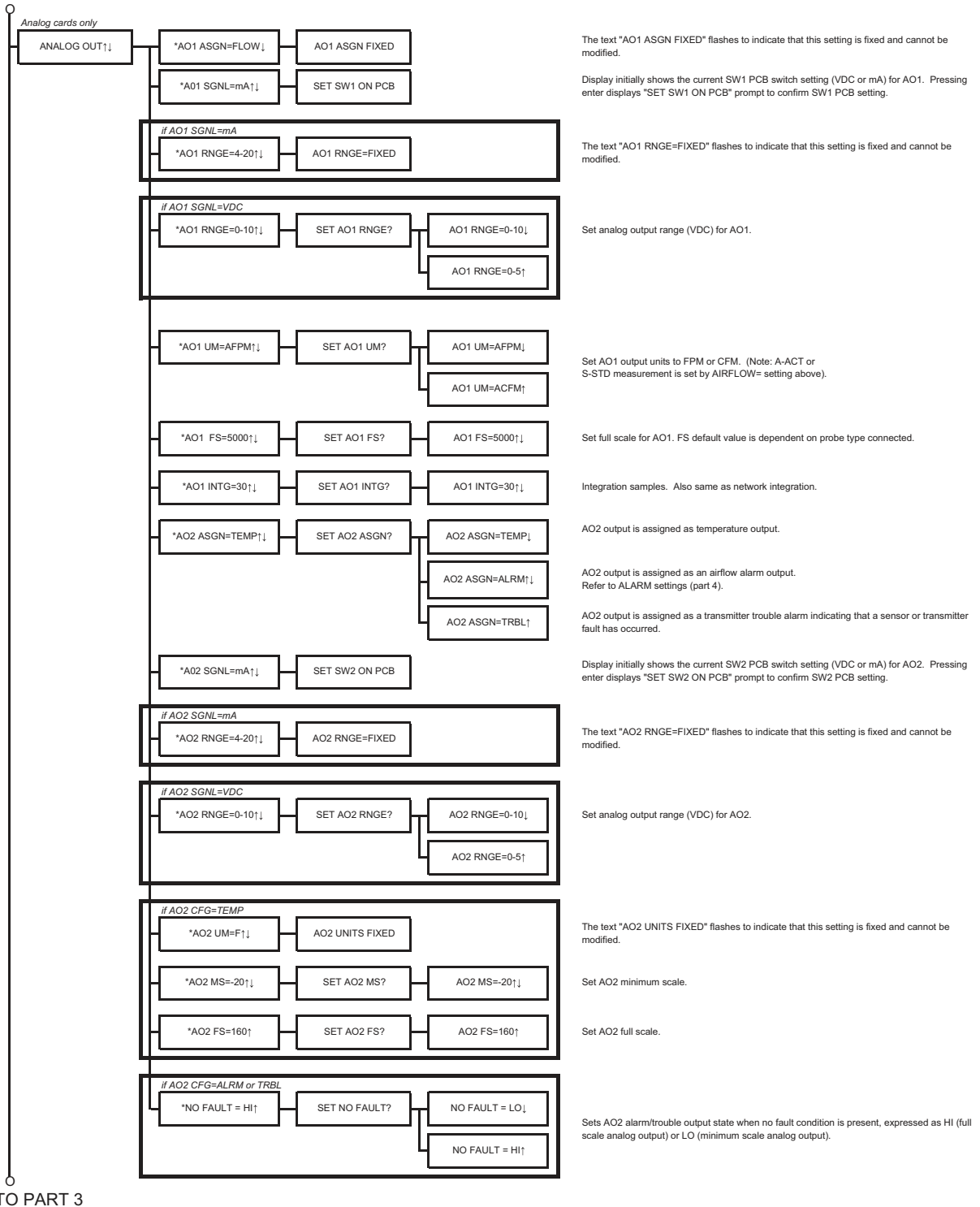

TM_GTx116_P2A

TO PART 3

TM_GTx116 Setup Menu (PART 3 OF 6)

FROM PART 2

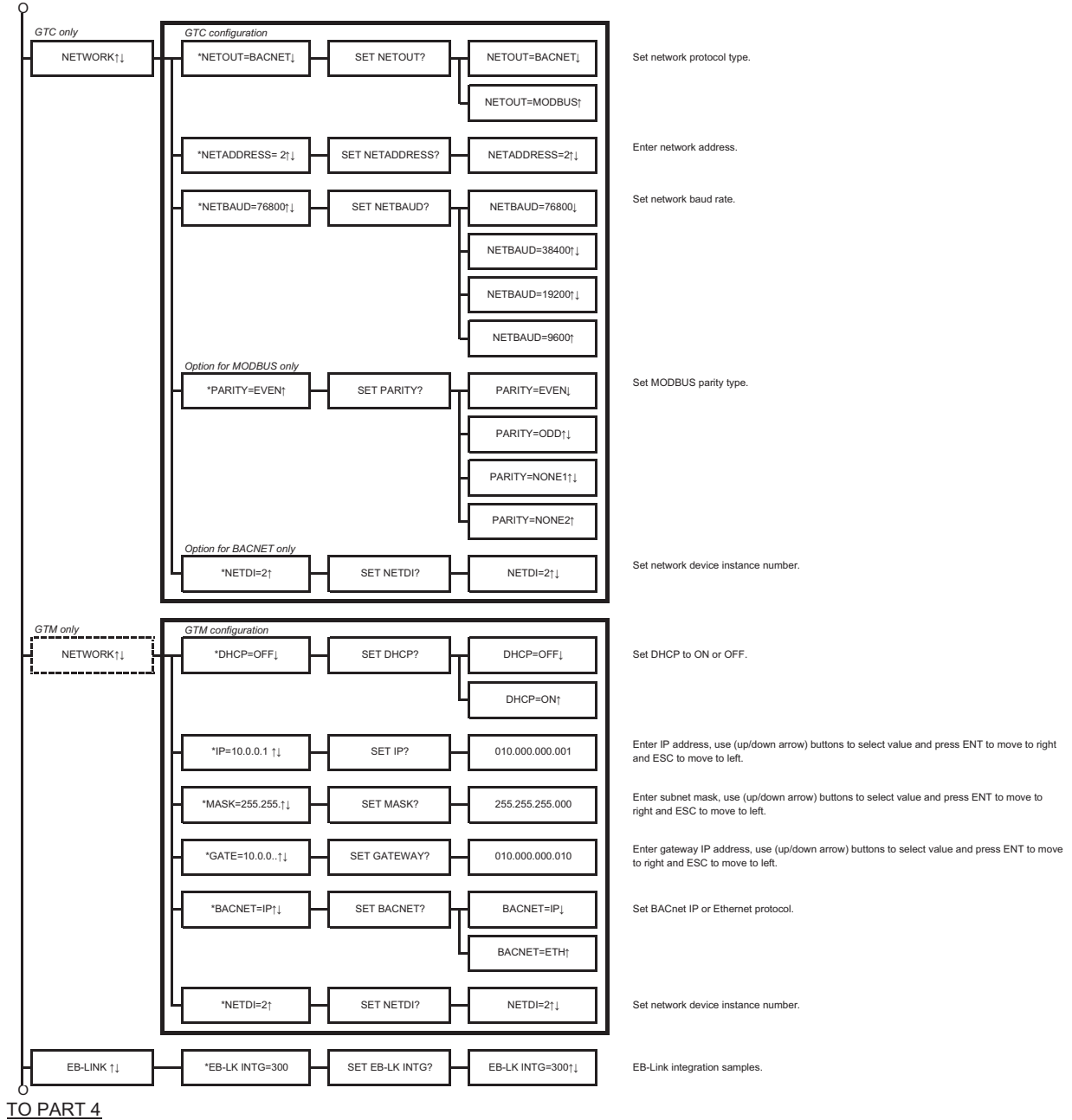

TM_GTx116 Setup Menu (PART 4 OF 6)

FROM PART 3

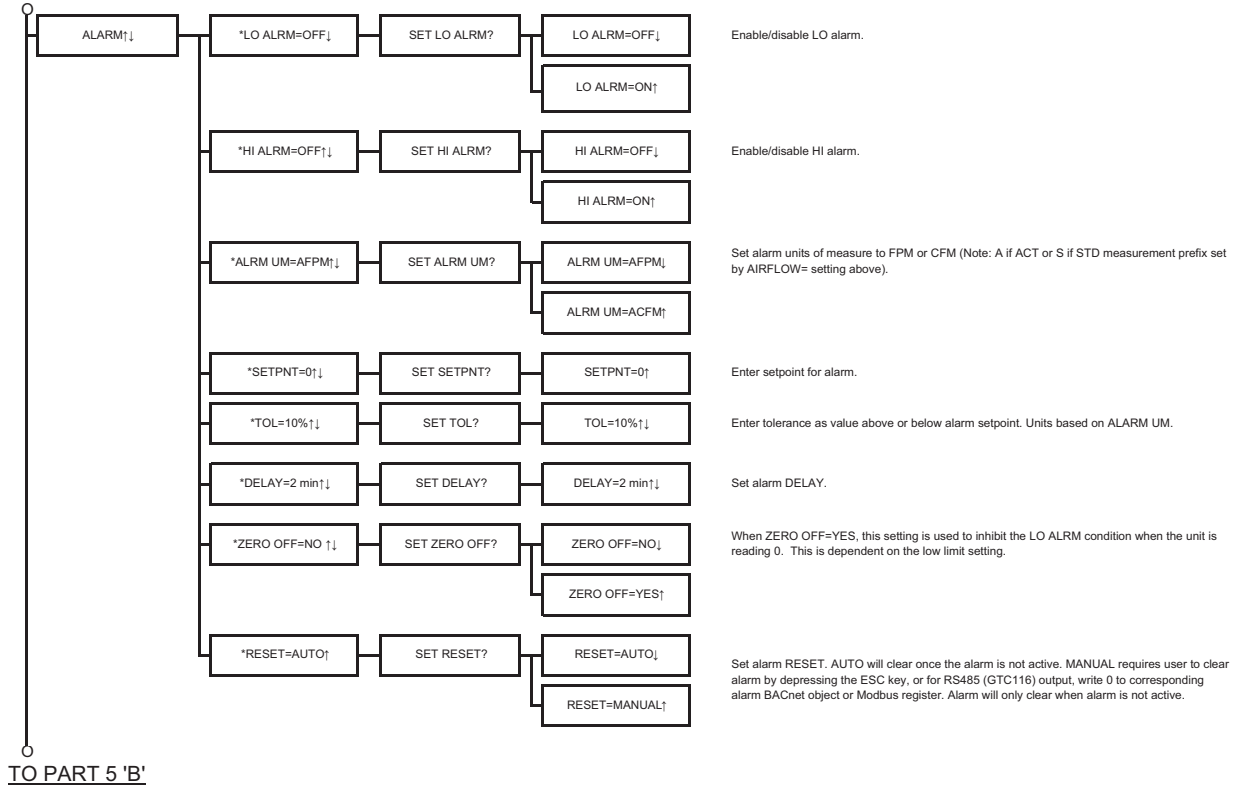

TM_GTx116 Setup Menu (PART 5 OF 6)

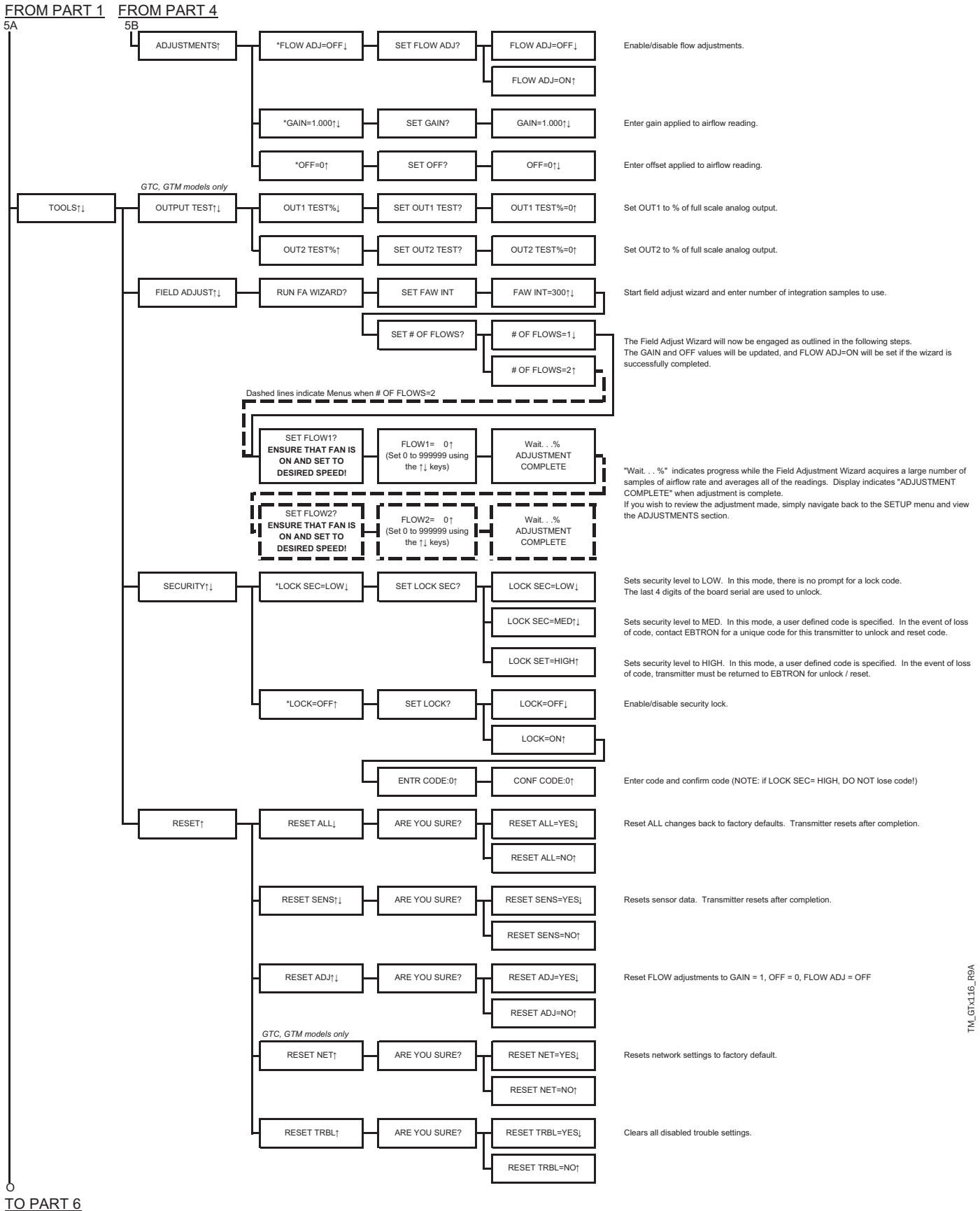

TM_GTx116 Setup Menu (PART 6 OF 6)

FROM PART 5

